

# 48

YILDIR BİTMEYEN  
YENİLİK TUTKUSU  
YEARS OF PASSION  
FOR INNOVATION

# KOCCEL®

*"Toparlayan Çözümler..."*

*"Organized Solutions..."*





Çekmeceli Dolaplar  
*Drawer Cabinets*

4-19



CNC Takım Dolapları  
*Cnc Tool Cabinets*

20-23



Bilgisayar Çalışma Dolapları  
*Computer Working Cabinets*

24-25



Endüstriyel Dolaplar  
*Industrial Cabinets*

26-33



Malzeme Dolapları  
*Material Cabinets*

34-39

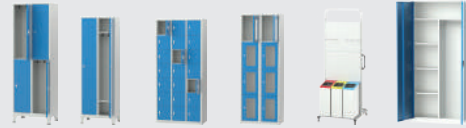

Personel Dolapları  
*Ppe Lockers*

40-43



Avadanlık Kutulu Sistemler  
*Linbin Systems*

44-51



Çalışma Masaları  
*Workbenches*

52-87



Çalışma Arabaları  
*Mobile Workbenches*

88-95



Takım Arabaları  
*Tool Carts*

96-101



Taşıma Arabaları  
*Handling Carts*

102-103

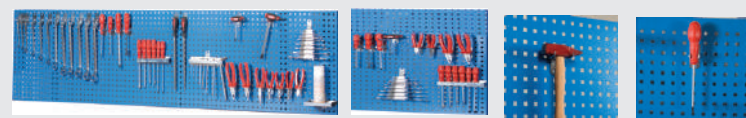

Takım Asma Panolar  
*Pegboards*

104-105



Raflama Sistemleri  
*Shelf Systems*

106-111

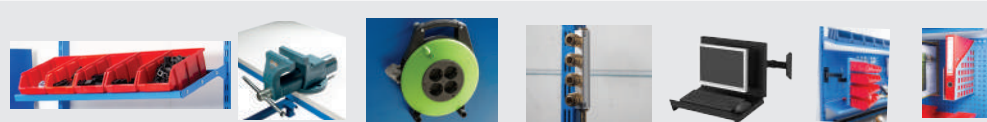

Aksesuar  
*Accessory*

112

# KOÇEL TARİHÇE KOÇEL TIMELINE

- 1977** - KOÇEL A.Ş. Zeytinburnu'nda 200m<sup>2</sup> lik bir alanda kuruldu.  
*KOÇEL A.Ş. was established in Zeytinburnu, Istanbul in a 200m<sup>2</sup> area.*
- 1979** - Çelik ve formika kaplama ev mobilyası üretmeye başladı.  
*Started producing steel and formica-coated household furniture.*
- 1985** - Bir müşterinin özel talebi ve çizimi doğrultusunda ilk çekmeceli dolabını üretti.  
*Produced the first drawer cabinet following the special request and design of a customer.*
- 1992** - Deneme numunelerinden sonra müşterilerden gelen talepler doğrultusunda çekmeceli dolap üretimine devam etti.  
*Continued to produce drawer cabinets based on the demand from customers after trial samples were made.*
- 2002** - Fuar katıldığımız ilk yıl.  
*The first year we participated in an exhibition.*

1992

1985

1979

1977

2002

2003

2010

- 2003** - Mahmutbey'de 1200m<sup>2</sup>'lik fabrika kuruldu ve artık 25 kişi olan ekiple beraber ürün yelpazesi de genişledi...  
*A factory was established in Mahmutbey, covering 1200m<sup>2</sup>, and the product range expanded along with a team of 25 people.*
- 2010** - Gebze Organize Sanayi Bölgesi'nde bulunan 7500m<sup>2</sup>'lik yeni fabrika binası satın alındı, üretimine burada devam etmeye başladı. KOÇEL A.Ş. gelişmiş teknolojisi, sektörün en usta ellerinden oluşan ekibi ve müşteri memnuniyetine olan inancı ile sadece ürün yelpazesini değil, müşteri potansiyelini de artırarak sektördeki yerini sağlamlaştırdı.  
*The factory building in the GOSB(Gebze Organized Industrial Zone), covering 7500m<sup>2</sup>, was purchased and production continued there. KOÇEL A.Ş., with its advanced technology and team of skilled professionals, not only expanded its product range but also strengthened its position in the industry by increasing its customer potential.*

2018

2014

2012

- 2012** - Genişleyen ürün yelpazesi.  
*Expanded product range.*
- 2014** - İhtacat başladığımız ilk yıllar; İspanya, Hollanda, Slovenya, Bulgaristan ve Fas'a ihracat yaptık.  
*The first years we started exporting; we exported to Spain, the Netherlands, Slovenia, Bulgaria, and Morocco.*
- 2018** - KOÇEL A.Ş. gelişen en son teknolojileri, üretimine ve ürünlerine adapte etmeye devam etti.  
*KOÇEL A.Ş. adapted its production and products to the latest technologies and continued expanding.*
- 2020** - Genişleyen iş hacminin getirdiği ihtiyaç doğrultusunda sektördeki en son teknolojik makina yatırımları ile makine parkurunu genişletmeye devam ediyor.  
*Continued to expand the machine park with the latest technological machine investments due to increasing business volume.*
- 2023** - 2023 yılında üretim alanımızı iki katına çıkartarak KOÇEL 2 fabrika binamızı bünyemize kattık.  
*In 2023, we doubled our production area by incorporating the second KOÇEL factory building into our operations.*

2020

2023

2027

- 2027** - Gelecekteki fabrikamız.  
*Our future factory.*

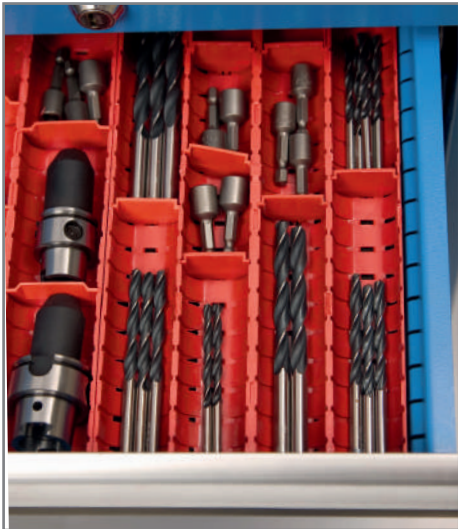
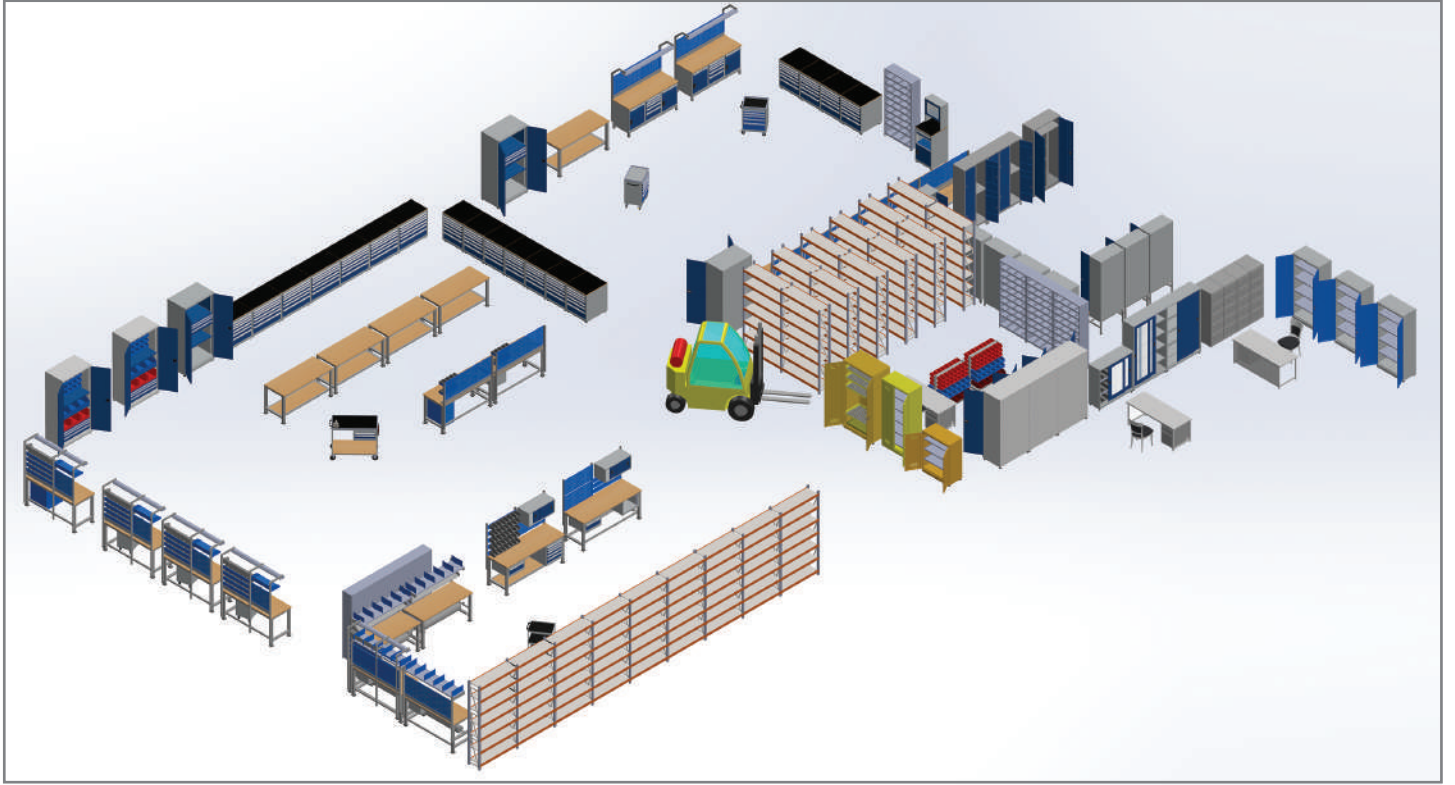

## FARPLAS A.Ş.

Okan AKBULUT  
Layout ve Yeni Yatırımlar Uzmanı

KOÇEL A.Ş. deyince aklımıza ilk gelen Giresunspor. Kaliteli Koçel ürünlerinden sonra çalışma alanlarımızı daha verimli kullanmaya başladık. KOÇEL A.Ş.'yi tercih etme sebebimiz ürünlerin kaliteli olması, zamanında geri dönüşler alabilmemiz ve ilave isteklerimizi karşılamada gösterdikleri anlayıştır.

Okan AKBULUT  
Layout and New Investments Specialist

*When we think of KOÇEL A.Ş., the first thing that comes to our mind is Giresunspor. After using KOÇEL's high quality products, we started to utilize our working spaces more efficiently. The reason we chose KOÇEL A.Ş. was the high quality of their products, the fast customer support we received, and their ability to meet our additional requests.*



## SAMSUN YURT SAVUNMA

Selçuk TEMELLİ / Teknik Müdür

KOÇEL firmasının ürünlerini birçok departmanımızda kullanmaktayız. Ürünlerinin kullanılabilirliği ve uzun ömürlü olması, tercih etmemizdeki başlıca nedenlerdir. Ayrıca, müşteri geri bildirimlerine verdikleri değeri de takdir ediyoruz. Özel tasarım taleplerimizde, hızlı ve çözüm odaklı geri dönüşler alıyoruz.

Selçuk TEMELLİ / Technical Manager

*We use Koçel's products across many of our departments. We prefer them due to their functionality and durability. Additionally, the company values customer feedback. When we request custom-designed products, we receive prompt and solution-oriented responses.*



## YILDIZ TEKNİK ÜNİVERSİTESİ

Doç. Dr. Alptekin ERGENÇ  
Makina Mühendisliği Bölüm Başkanı Yardımcısı

Otomotiv Laboratuvarımız ile YTU Racing garajının yenilenmesinde KOÇEL A.Ş.'nin farklı ürünleri tercih edilmiş ve laboratuvara gelen tüm öğrencilerimiz ile misafirlerimizin beğenisini kazanan bir görsel ve fonksiyonel uyum ortaya çıkmıştır. Boya, malzeme kalitesi, ve müşteri memnuniyeti anlayışının, söz konusu çalışma alanlarındaki uyumun temel nedeni olduğunu düşünüyoruz.

Ass. Prof. Alptekin ERGENÇ  
Vice President, Dep. for Machine Engineering

*During the renovation of our Automotive Laboratory and the YTU Racing garage, various KOÇEL A.Ş. products were chosen, which brought about a visual and functional harmony appreciated by all the students and guests who visit the laboratory. We believe that the paint quality, material quality, and customer satisfaction approach were the main reasons for the harmony in these workspaces.*



## TOYOTETSU TÜRKİYE

Fikret YAVUZ / İnsan Kaynakları ve İdari İşler Md. Yrd.

KOÇEL A.Ş. firmasını düşündüğümüz zaman ilk aklımıza gelen kalitedir. Çeşitliliği ve özel tasarımları sayesinde KOÇEL A.Ş. ürünleri ile firmamızda düzen ve tertip sağlandı. Ürünlerin uzun ömürlü olması ve sorunsuz rahat kullanımı tercihimizdeki en önemli sebeptir. Kaliteli ve dayanıklı olduğu için, alınan ürünleri uzun yıllar sorunsuz kullanmaktayız.

Fikret YAVUZ / Assistant Manager of Human Resources and Administrative Affairs

*When we think of KOÇEL A.Ş., the first thing that comes to our mind is quality. Thanks to the variety and special designs, KOÇEL A.Ş. products brought order and organization to our company. The fact that the products are long-lasting and provide smooth, easy usage was the most important reason for our preference. Since KOÇEL A.Ş. products are high quality and durable, we have been using them seamlessly for many years.*



## GES GENEL ELEKTRİK SİSTEMLERİ

Musa ÇORBACI  
Yönetim Kurulu Başkanı

Taşındığımız yeni tesisimizde depo kısmında Koçel tarafından bize sunulan çözümler ile hedeflediğimiz düzeni sağladık. İhtiyacımıza yönelik olarak çözüm odaklı ve profesyonel yaklaşımları sayesinde süreci çok hızlı ve kolay bir şekilde yönettik. Kalitesinin yanı sıra satış sonrası verdikleri destekle bizlere çok yardımcı oldular. Bu performansları için Koçel ailesine teşekkür ederiz.

Musa ÇORBACI / Chairman of the Board

*When we moved to our new facility, we organized our warehouse section with solutions provided by KOÇEL. We managed this process very quickly and easily thanks to their solution-oriented and professional approach. Not only their quality but also the after-sales support they provided was very helpful to us. We thank the KOÇEL family for this performance.*



## YUKİ

Aydan ALPAZAR  
Yedek Parça Sorumlusu

Yıllardır KOÇEL A.Ş. ürünlerini kullanıyoruz ve oldukça başarılı buluyoruz, daha rahat ve sistemli bir düzen kurmamıza da yardımcı oldu. Hizmet ve kaliteyi her zaman önde tuttuğu için başka bir marka düşünmedik bile, çünkü biliyoruz ki iyi kalite, iyi hizmetin dışında iyi fiyat ile de yine önde olacak.

Aydan ALPAZAR  
Spare Parts Manager

*We have been using KOÇEL A.Ş.'s products for years, and we find them extremely useful. Their products helped us establish a more comfortable and systematic organization. Since KOÇEL prioritizes service and quality, we never even considered another brand, because we know that good quality, good service, and good prices will always keep them ahead.*



## SARIGÖL KONVOYÖR

Salih SARIGÖL  
Genel Müdür

Yeni fabrikamızda tüm istasyon, raf sistemlerini ve personel soyunma dolapları KOÇEL firmasından satın aldık. İki senedir sorunsuz problemsiz şekilde kullanmaktayız. KOÇEL firması kalitesi ve yüksek standartları ile bizleri memnun etmiştir. Sarigöl Ailesi olarak bu performansları için KOÇEL Ailesine teşekkürlerimiz sunuyoruz.

Salih SARIGÖL  
General Manager

*In our new factory, we purchased all the station systems, shelving systems, and employee locker cabinets from KOÇEL. We have been using them smoothly without any problems for more than two years. KOÇEL's quality and high standards have made us very satisfied. As the Sarigöl family, thanks to the KOÇEL family for this performance.*



## GİRSAN SİLAH

Hamdi Can OTURAK  
Makina Mühendisi

2021 yeni taşınmış olduğumuz fabrikamızda tüm çalışma alanlarını KOÇEL çelik firmasının ürünleri ile donattık. Yıllar geçtikçe tercihimizi ne kadar doğru olduğu kanaatine vardık. KOÇEL ürünleri kalitesi ve ergonomik kullanımı ile işlerimizi kolaylaştırmanın yanı sıra sağlamlığı ile de tüm fabrikamızda toparlayan çözümler üretmiştir.

Hamdi Can OTURAK  
Mechanical Engineer

*In 2021, we moved to our new factory, where we equipped all the working areas with KOÇEL products. As the years passed, we realized how right our decision was. The quality and ergonomic usage of KOÇEL products have not only facilitated our work but also provided strength and durability, creating solutions that organized our entire factory.*



18X27 E

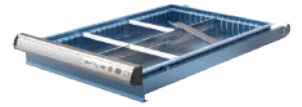
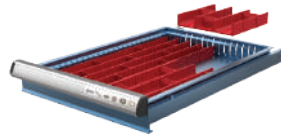
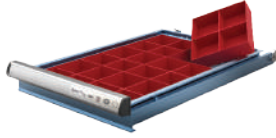
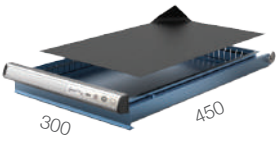

Merkezi Kilit  
Central Lock



Rotil Ayak  
Ball Joint Feet

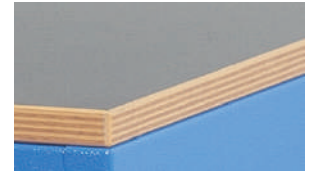

18mm Suntalam Tabla  
18mm MC Chipboard Top



Profesyonel Etiketleme  
Professional Labelling



Güvenli Çekmece  
Secure Drawer





kod 1030



kod 1031



kod 1040



kod 1041



kod 1042



kod 1060



kod 1061



kod 1062

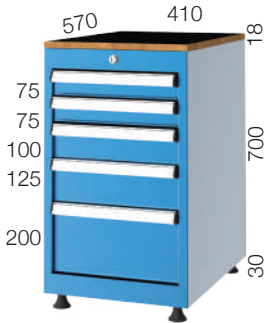

kod 1070

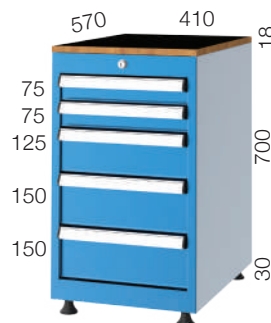

kod 1071

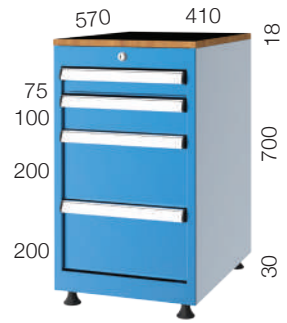

kod 1072

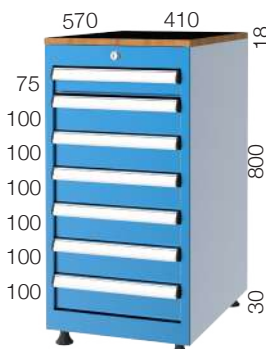

kod 1080

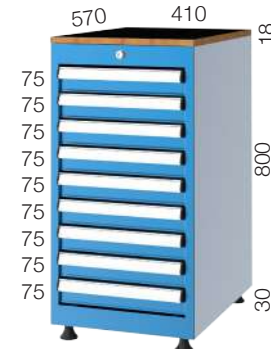

kod 1081

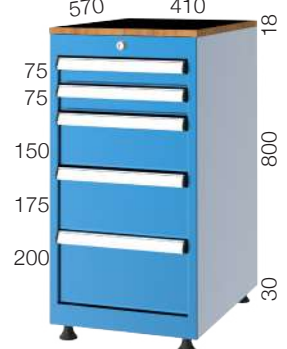

kod 1082

27X27 E

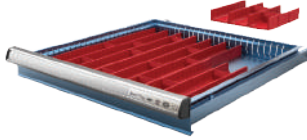
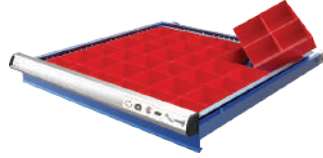
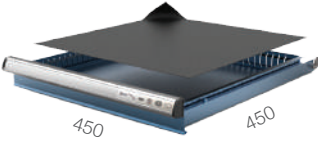

Merkezi Kilit  
Central Lock



Rotil Ayak  
Ball Joint Feet

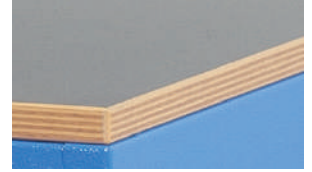

18mm Suntalam Tabla  
18mm MC Chipboard Top



Profesyonel Etiketleme  
Professional Labelling



Güvenli Çekmece  
Secure Drawer



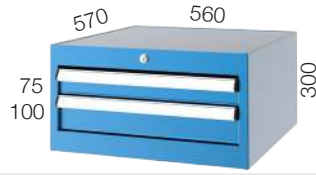

kod 5030



kod 5031

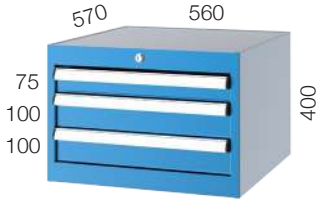

kod 5040



kod 5041



kod 5042



kod 5060



kod 5061



kod 5062

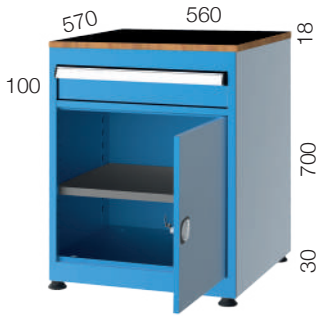

kod 5071

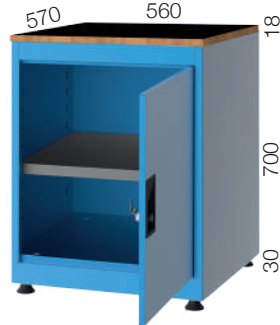

kod 5072



kod 5075

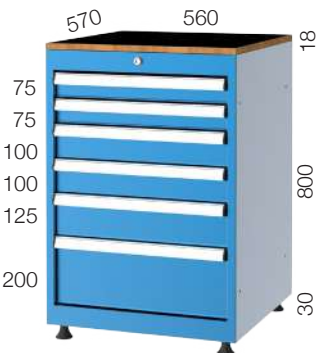

kod 5080

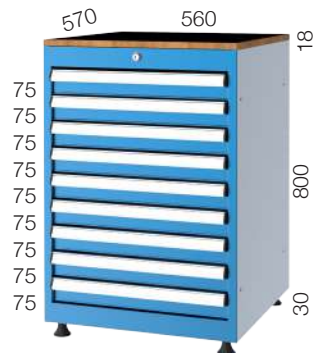

kod 5081

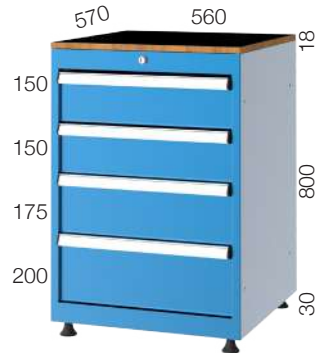

kod 5082

27X27 E

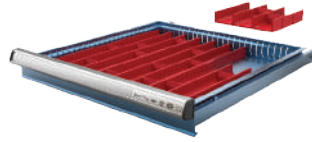
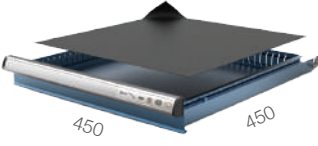

Merkezi Kilit  
Central Lock



Rotil Ayak  
Ball Joint Feet

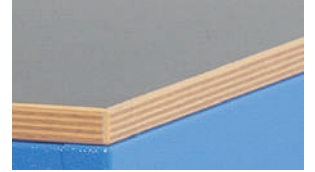

18mm Suntalam Tabla  
18mm MC Chipboard Top



Profesyonel Etiketleme  
Professional Labelling

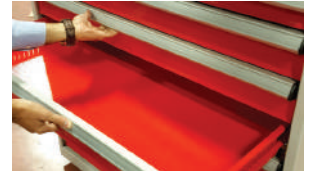

Güvenli Çekmece  
Secure Drawer

1,80 m

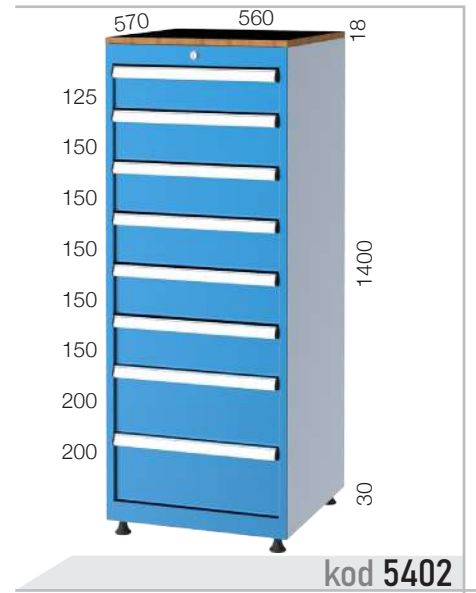
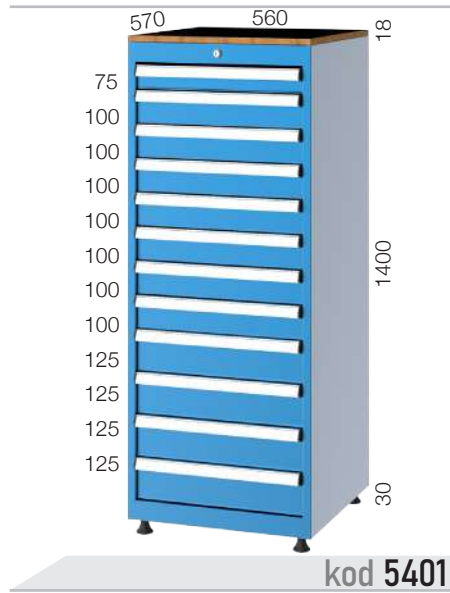
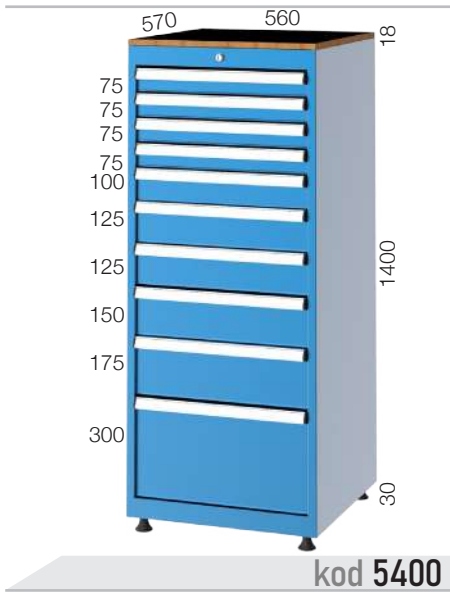
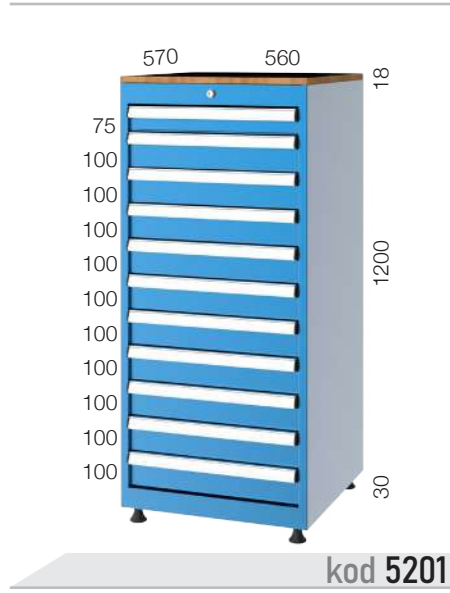
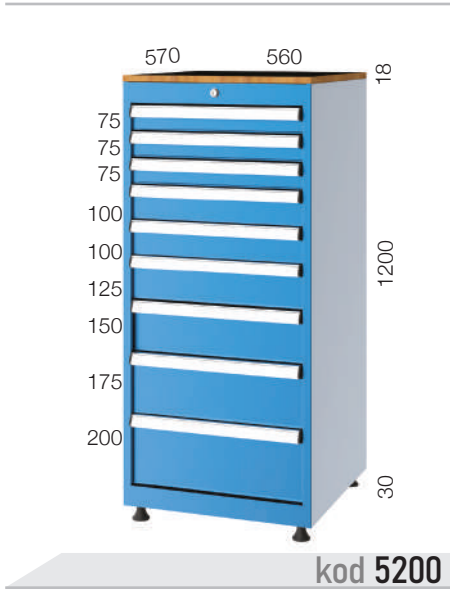
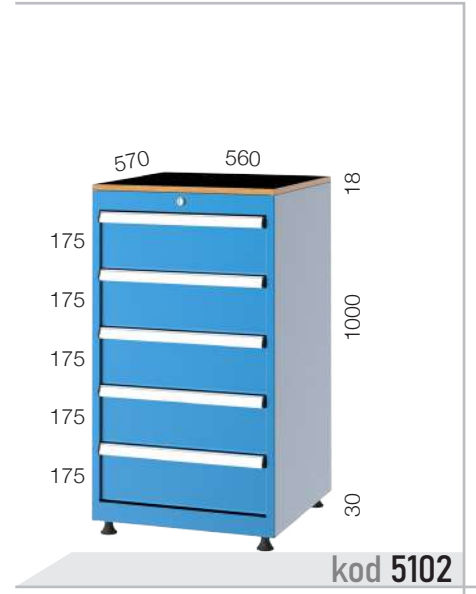
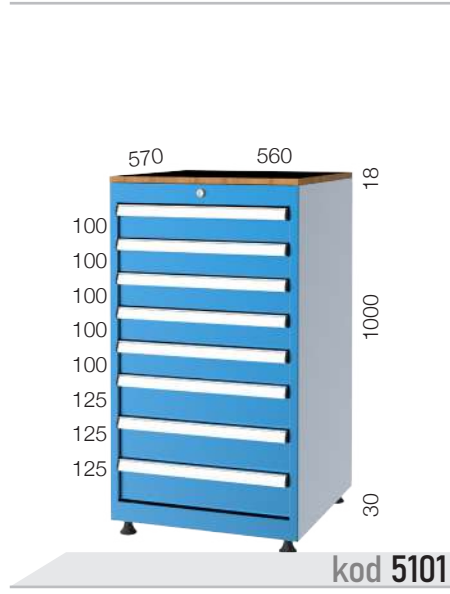
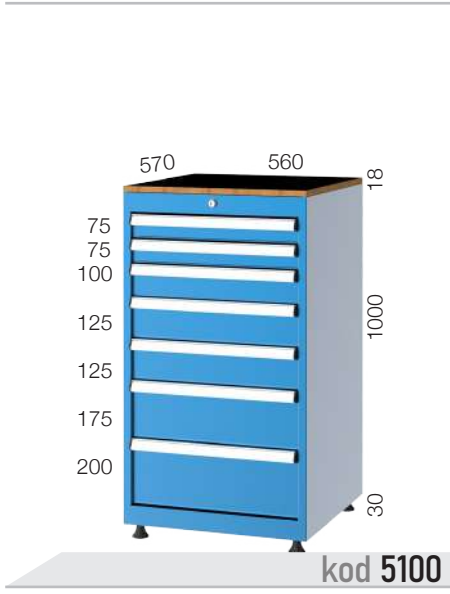

27X36 E

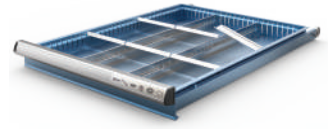
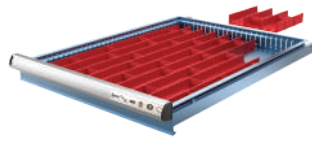
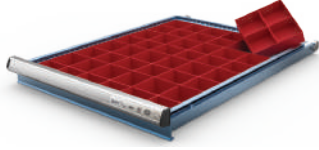
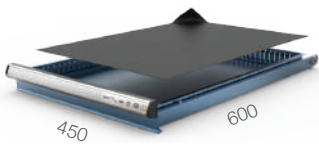

Merkezi Kilit  
Central Lock

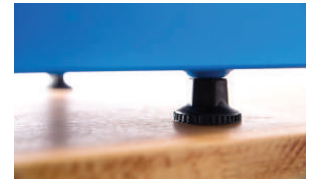

Rotil Ayak  
Ball Joint Feet

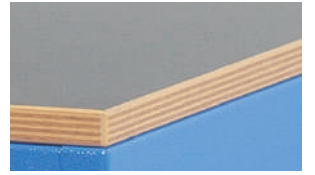

18mm Suntalam Tabla  
18mm MC Chipboard Top



Profesyonel Etiketleme  
Professional Labelling



Güvenli Çekmece  
Secure Drawer

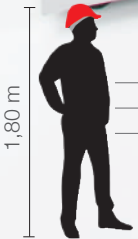

1,80 m



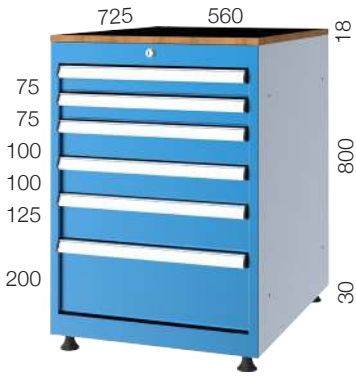

kod 57080

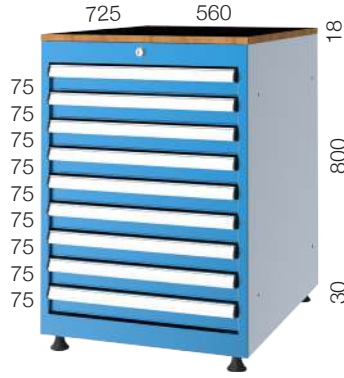

kod 57081



kod 57082

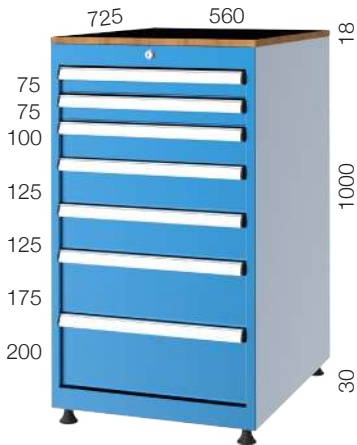

kod 57100

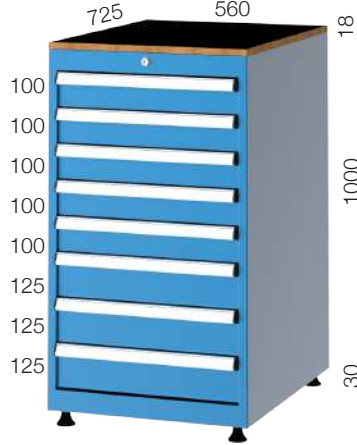

kod 57101



kod 57102

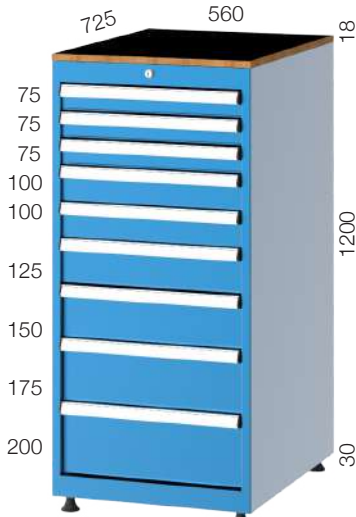

kod 57200

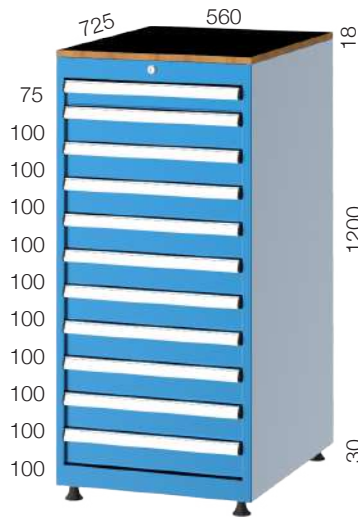

kod 57201

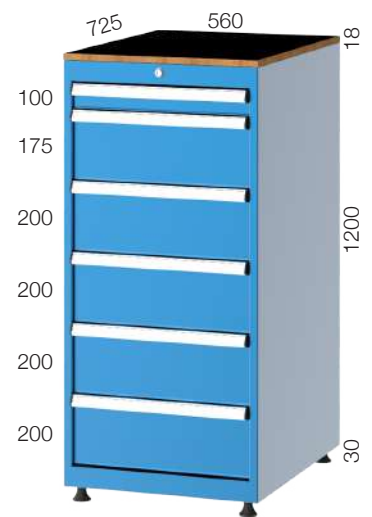

kod 57202

36X27 E

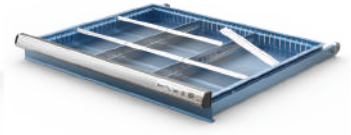
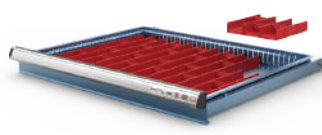
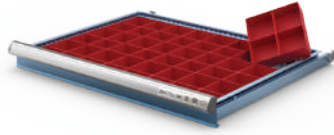
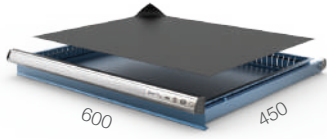

Merkezi Kilit  
Central Lock



Rotil Ayak  
Ball Joint Feet

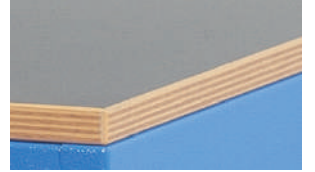

18mm Suntalam Tabla  
18mm MC Chipboard Top



Profesyonel Etiketleme  
Professional Labelling



Güvenli Çekmece  
Secure Drawer





kod 75080

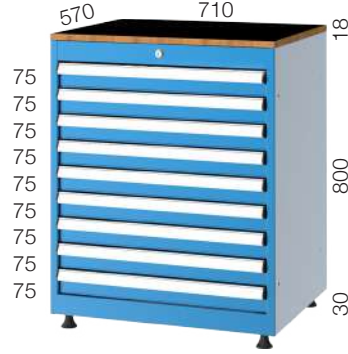

kod 75081



kod 75082

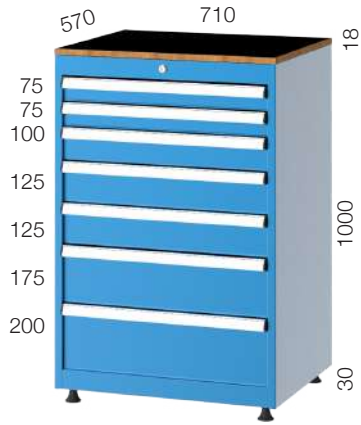

kod 75100

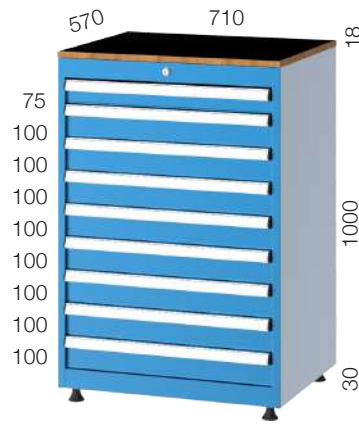

kod 75101

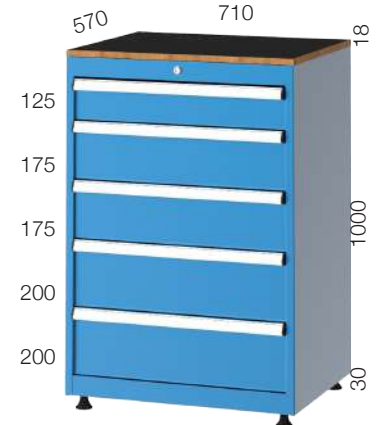

kod 75102

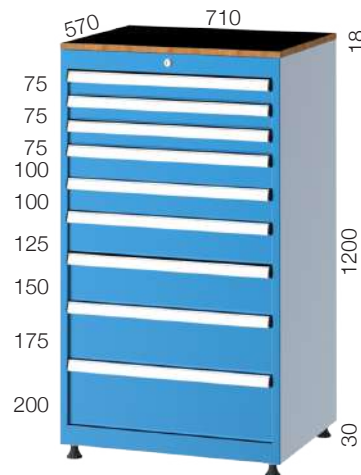

kod 75200

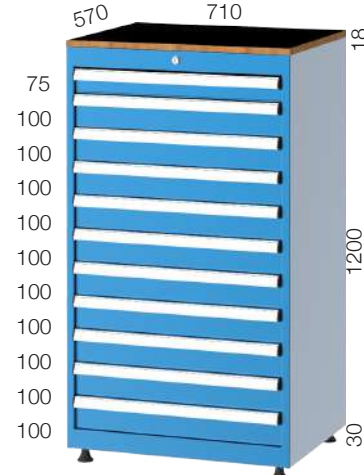

kod 75201

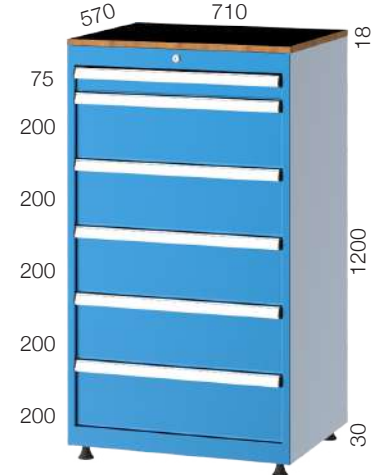

kod 75202

36x36 E

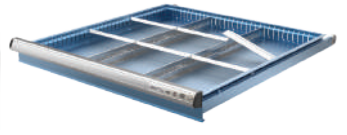
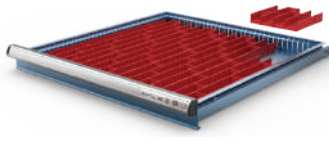
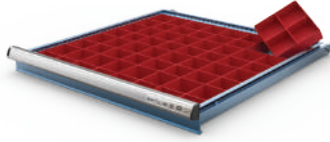
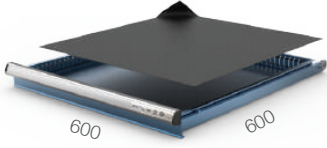

Merkezi Kilit  
Central Lock



Rotil Ayak  
Ball Joint Feet

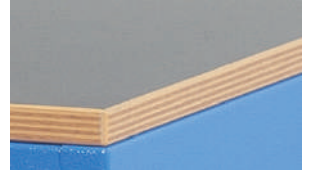

18mm Suntalam Tabla  
18mm MC Chipboard Top



Profesyonel Etiketleme  
Professional Labelling



Güvenli Çekmece  
Secure Drawer



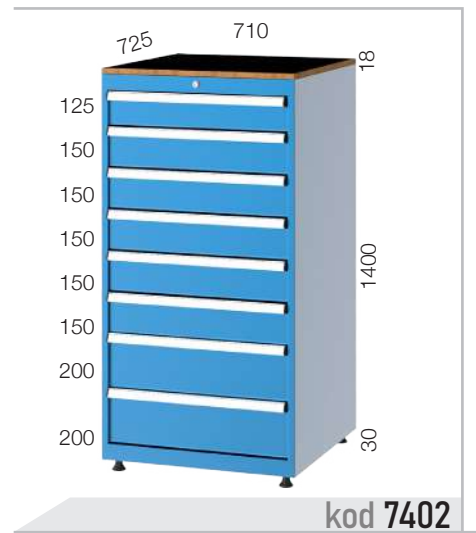
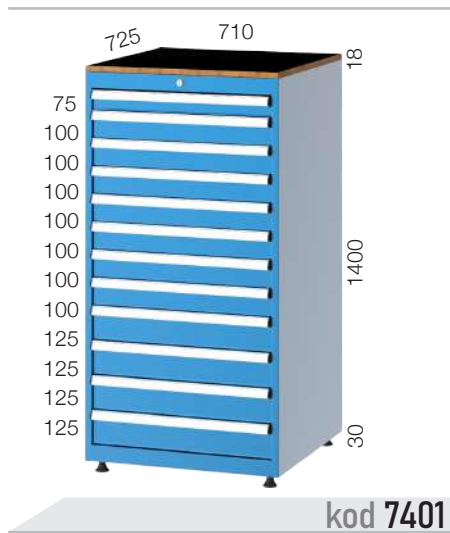
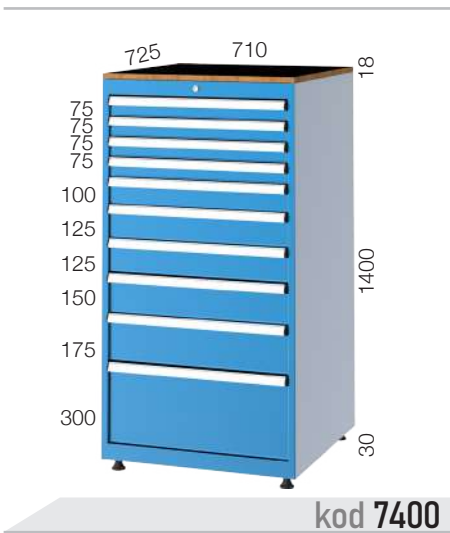
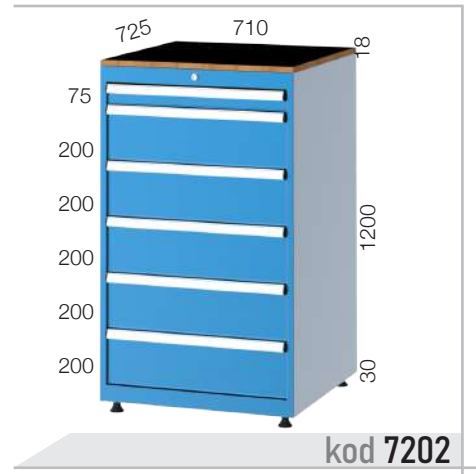
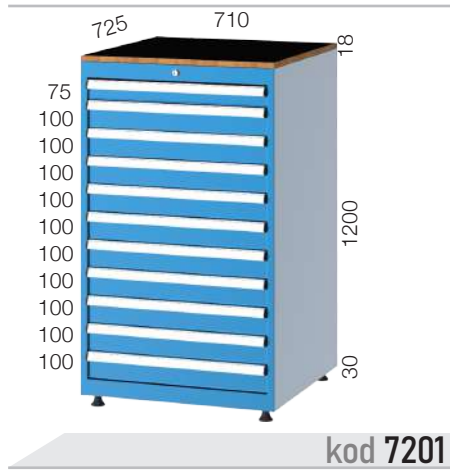
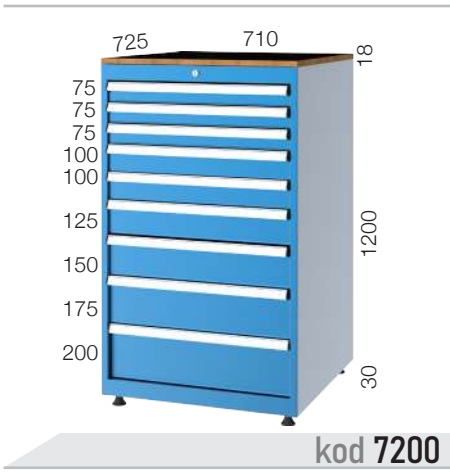
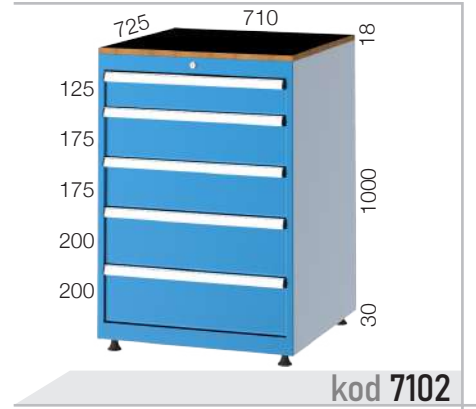
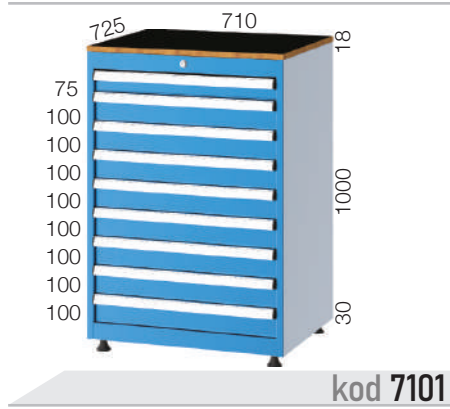
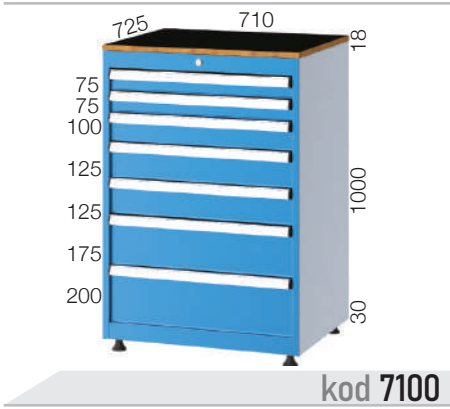
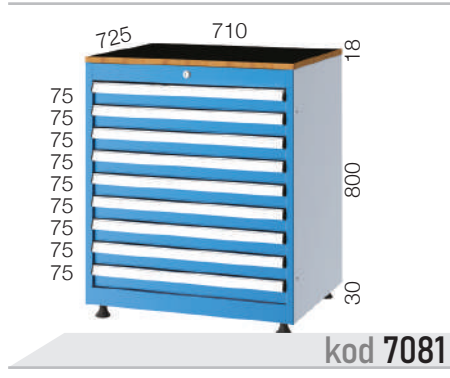

27X54 E

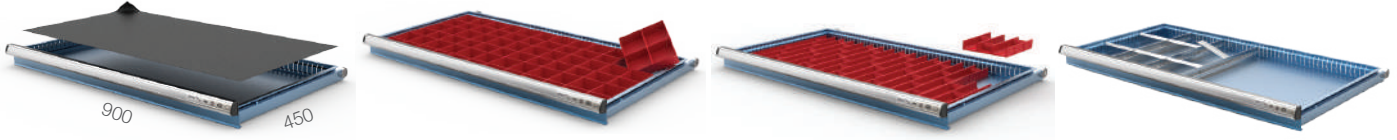

Merkezi Kilit  
Central Lock



Rotil Ayak  
Ball Joint Feet

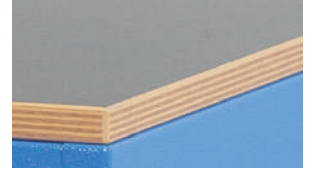

18mm Suntalam Tabla  
18mm MC Chipboard Top



Profesyonel Etiketleme  
Professional Labelling



Güvenli Çekmece  
Secure Drawer





kod 10080



kod 10081



kod 10082



kod 10100



kod 10101



kod 10102

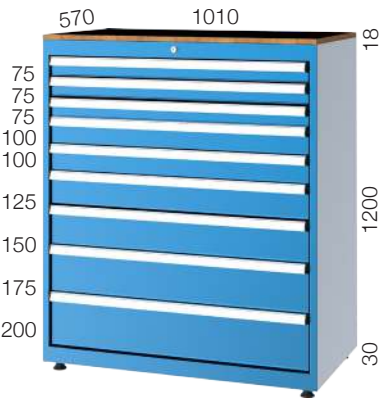

kod 10200

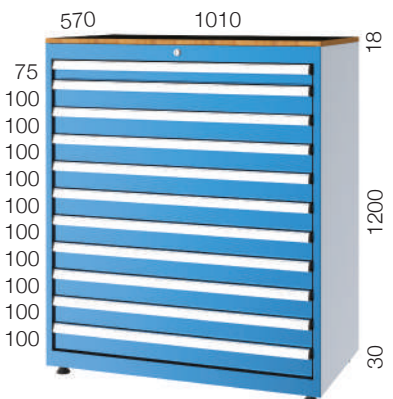

kod 10201



kod 10202

36x54 E

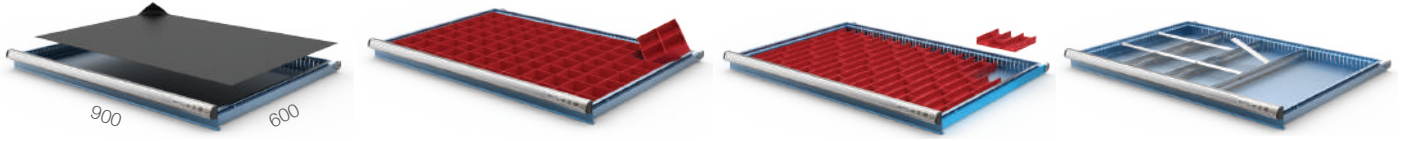

Merkezi Kilit  
Central Lock



Rotil Ayak  
Ball Joint Feet

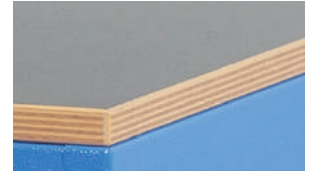

18mm Suntalam Tabla  
18mm MC Chipboard Top



Profesyonel Etiketleme  
Professional Labelling



Güvenli Çekmece  
Secure Drawer



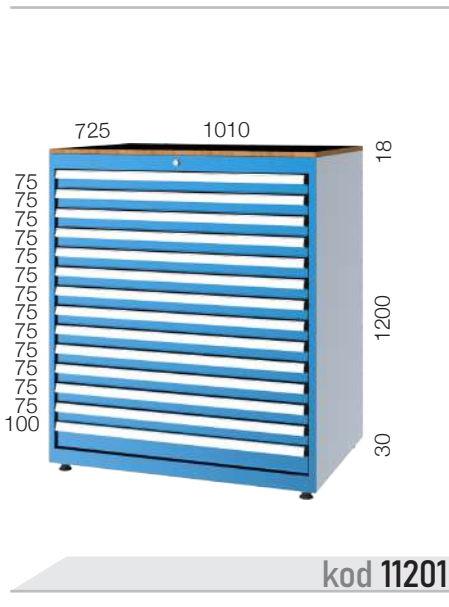
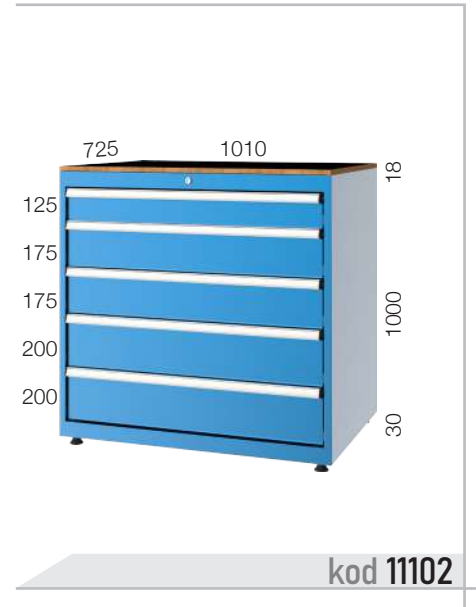
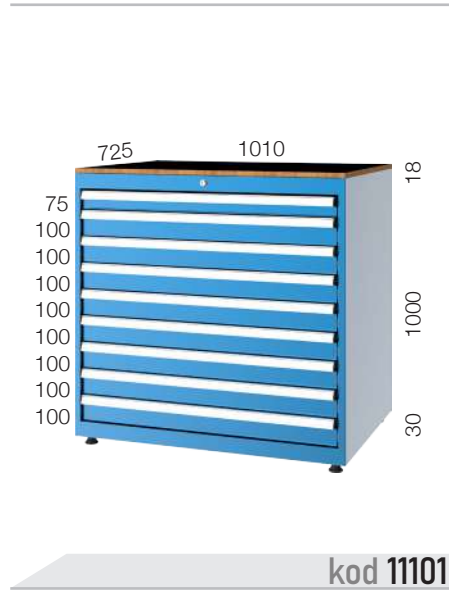
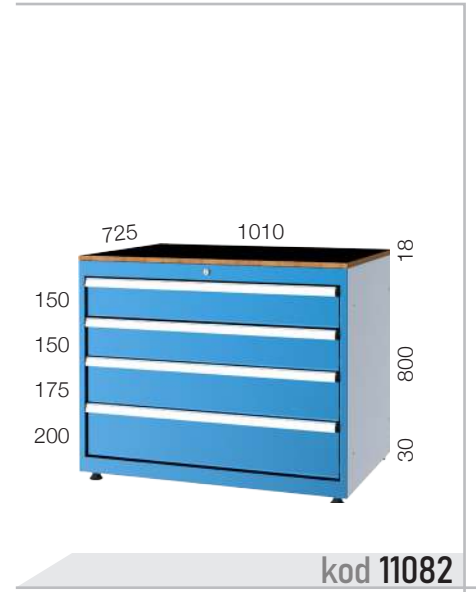
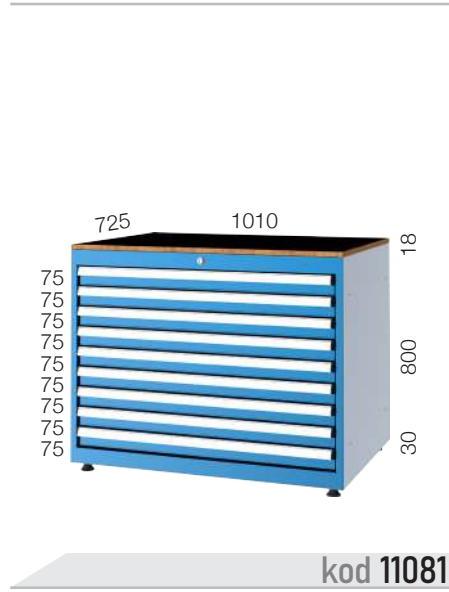
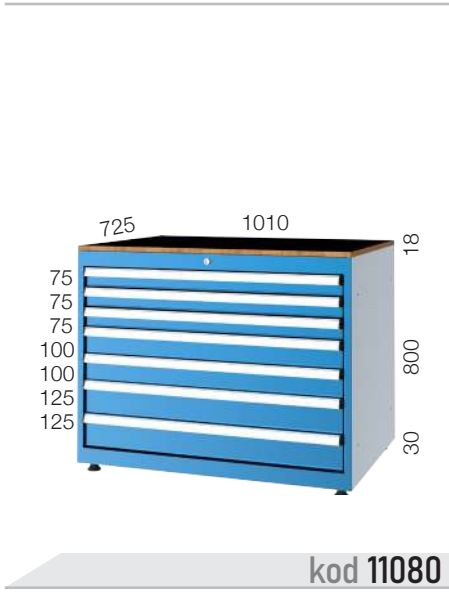

27X54 E

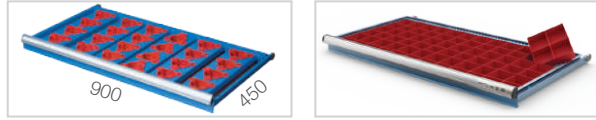
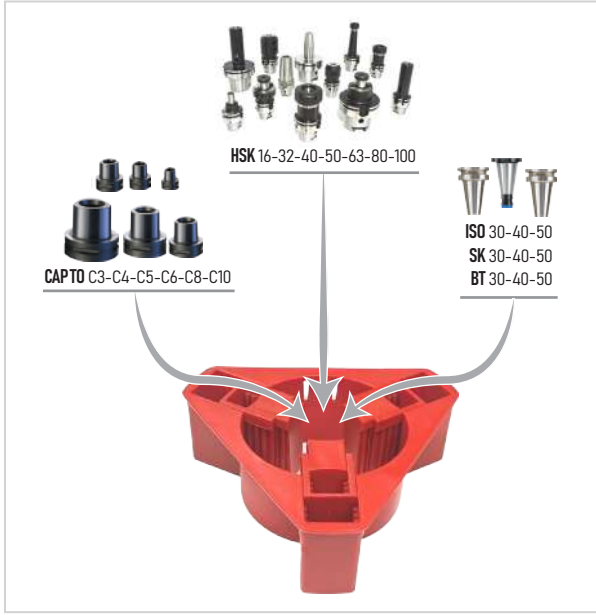

24 adet CNC tutucu kapasiteli  
24 pcs CNC holder capacity

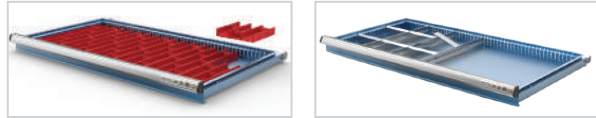

	450 450	600 600	450 900	500 300 570
ISO-SK 30	12	20	24	16
ISO-SK 40	12	20	24	16
ISO-SK 50	12	20	24	16
HSK 16	12	20	24	16
HSK 32	12	20	24	16
HSK 40	12	20	24	16
HSK 50	12	20	24	16
HSK 63	12	20	24	16
HSK 80	12	20	24	16
HSK 100	12	20	24	16
Capto C3	12	20	24	16
Capto C4	12	20	24	16
Capto C5	12	20	24	16
Capto C6	12	20	24	16
Capto C8	12	20	24	16
Capto C10	12	20	24	16

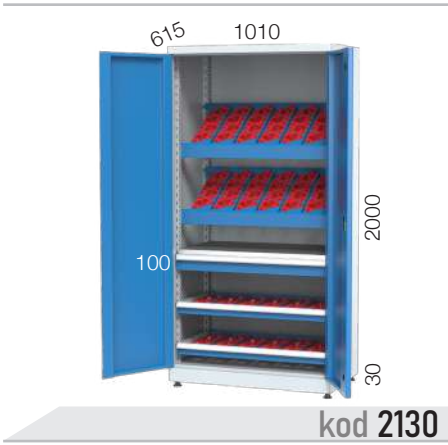
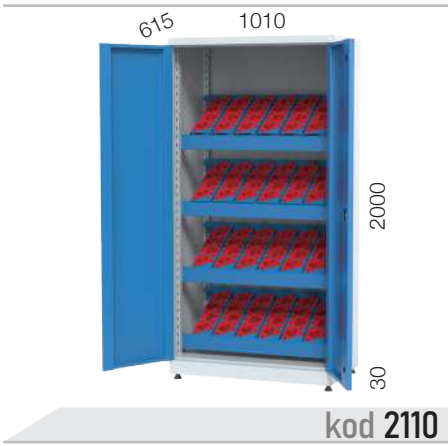



kod 2200

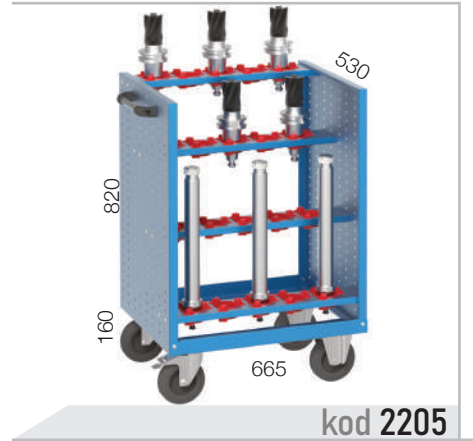

kod 2205

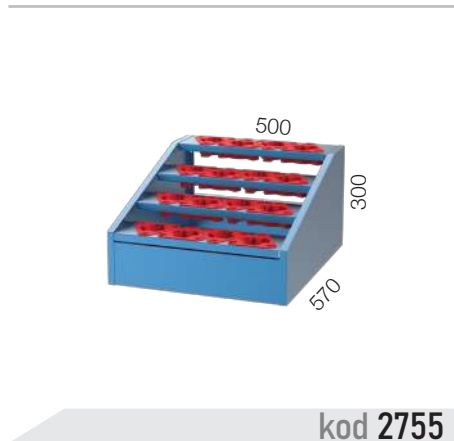

kod 2755

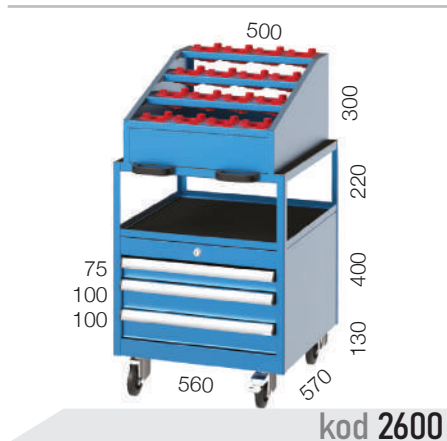

kod 2600



kod 2730



kod 2700



kod 2750



kod 2850



kod 2630



kod 2740



kod 2620



kod 2325



kod 2326

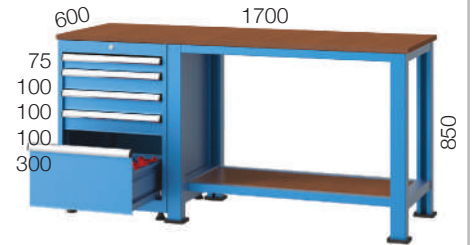

kod 2176



kod 2310



kod 2351



kod 2350

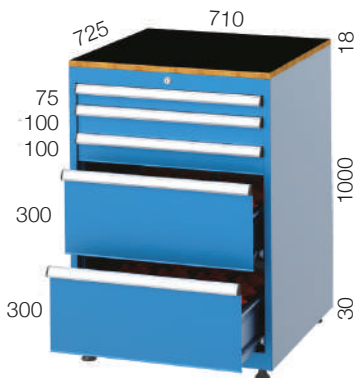

kod 2570

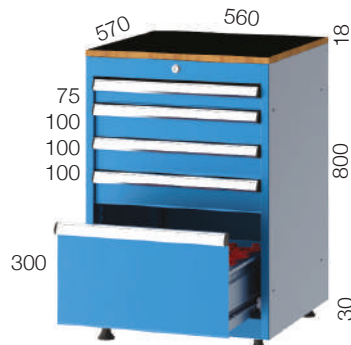

kod 2650



kod 2550



Ispanyolet Kilit  
Espagnolette Lock



Mandalı Kilit  
Latch Lock



Klavye Yükseltme Tablası\*  
Keyboard Elevating Tray

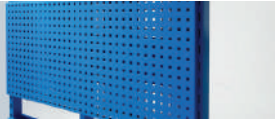

Askı Panosu  
Pegboard



Havalandırma Alanı  
Aeration Area



Uzatma Kablolü 4'lü Priz  
Quadruple Socket with Extension Cable



Tekerlek\*  
Wheel\*



Fan\*  
Ventilation\*



Sürgülü Ekran Kapağı  
Sliding Screen Cover

\*Opsiyonel \*Optional



kod 7350



kod 7422

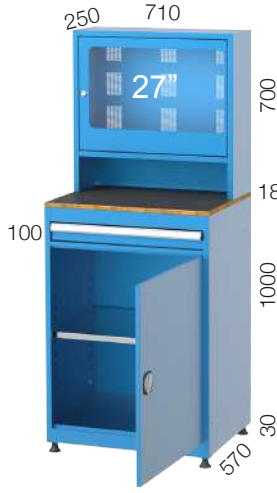

kod 7340

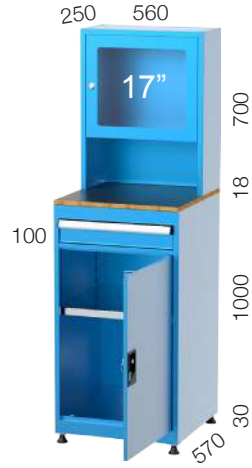

kod 7440

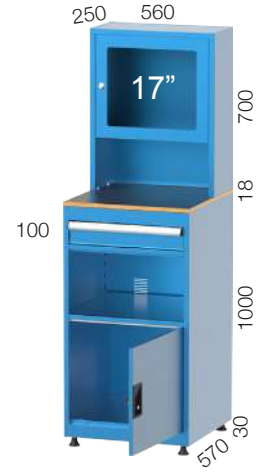

kod 7441



kod 7442

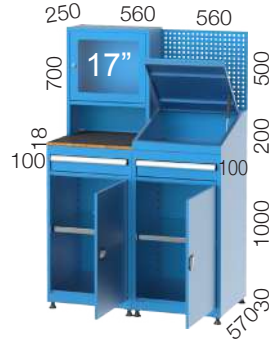

kod 7445

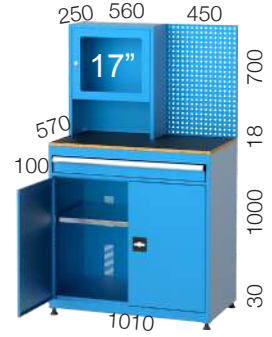

kod 7435

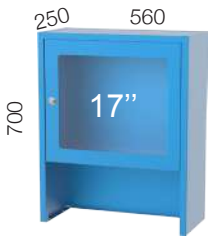

kod 7365

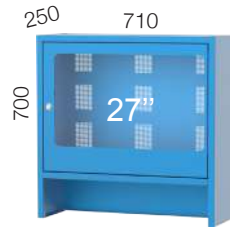

kod 7335



kod 7425

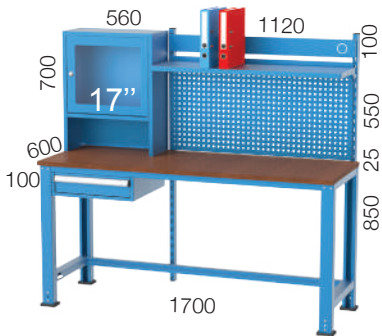

kod 7320



kod 7325

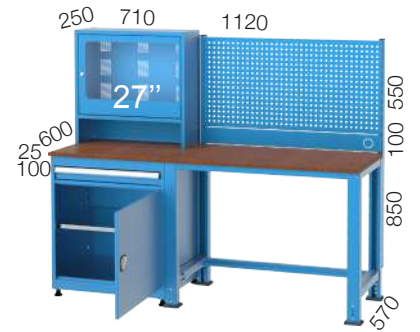

kod 7345



kod 6805



kod 6800



kod 7083



kod 6710

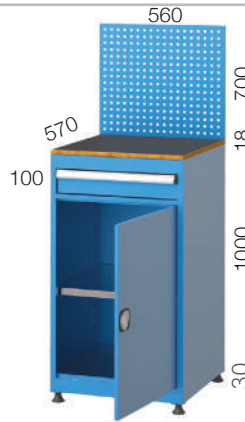

kod 6720

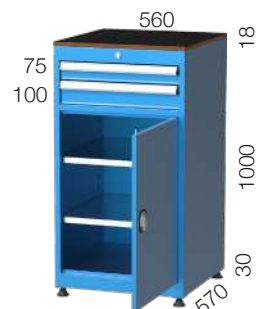

kod 5115

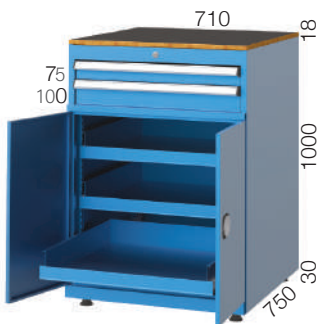

kod 7110



kod 5145



kod 6715

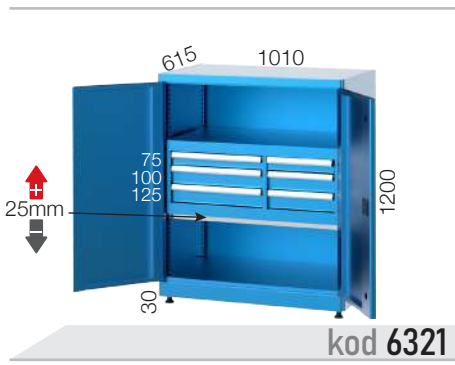
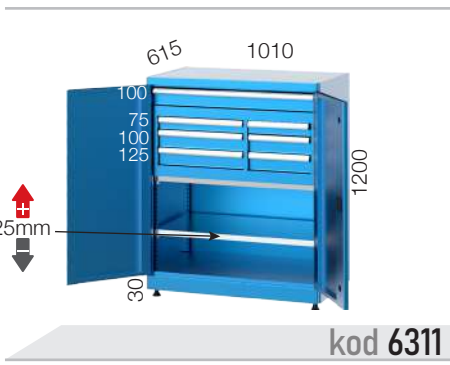
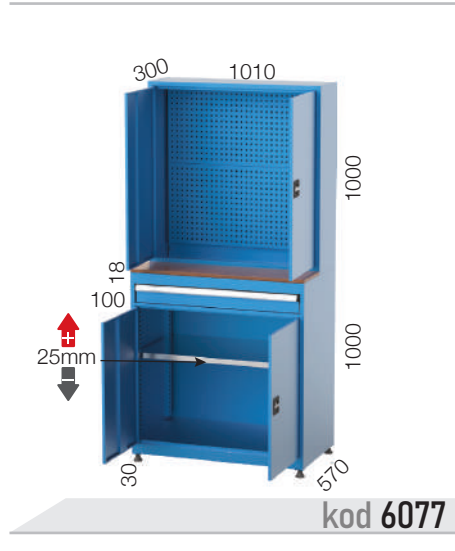
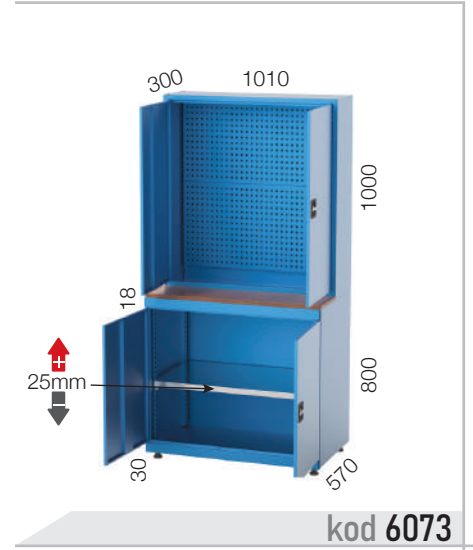
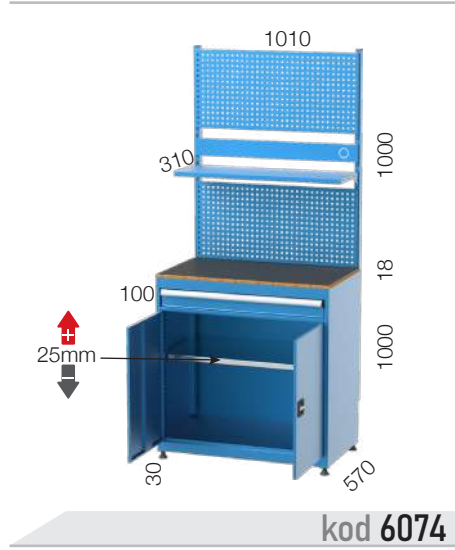
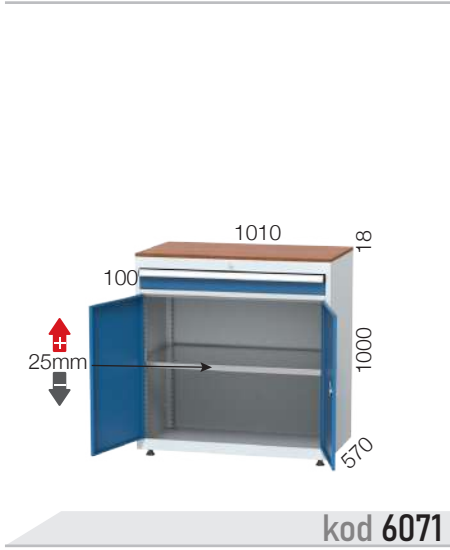



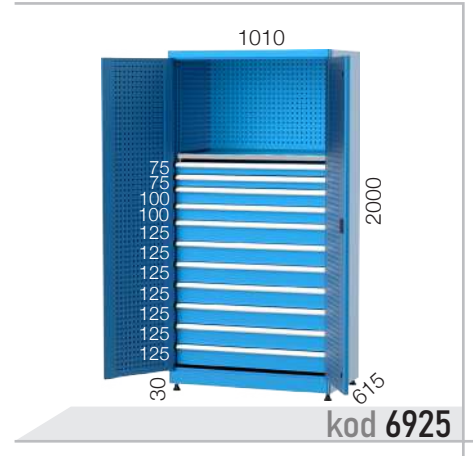
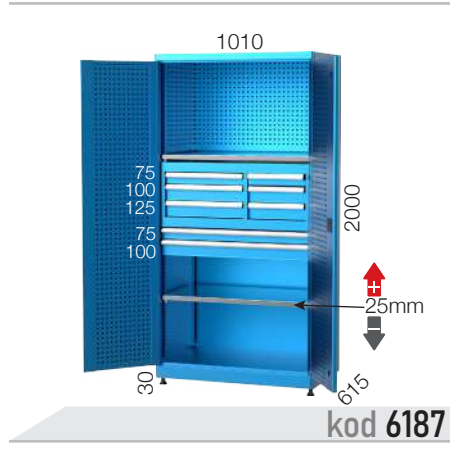
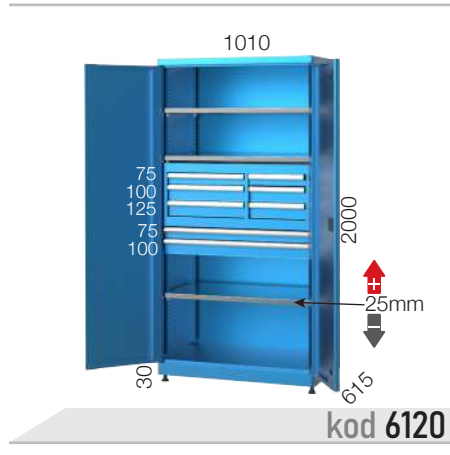

AVADANLIK KUTULARI

LINBINS



A-100

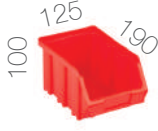

A-150



A-200

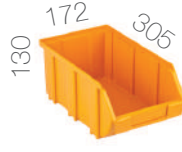

A-250



A-400



HPAV-27



27x54 E

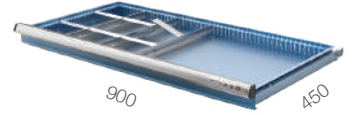

Avadanlık Rafı  
LinBin Shelf



Rotil Ayak  
Ball Joint Feet



İspanyolet Kilit  
Espagnolette Lock



Profesyonel Etiketleme  
Professional Labelling



Güvenli Çekmece  
Secure Drawer

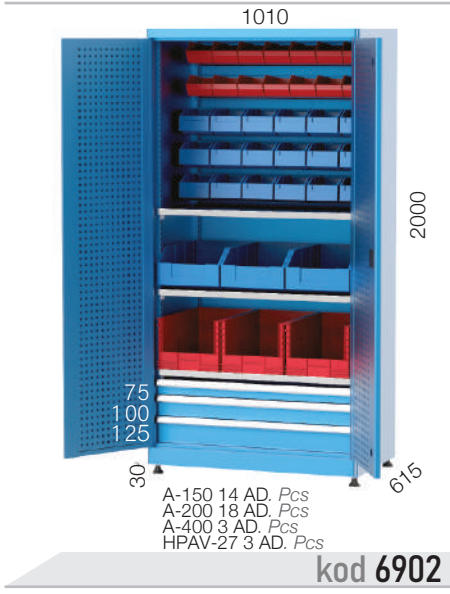



KOCEL®

Kimyasal malzeme dolaplarımızın metal olması dışında ısıya / yangına ekstra dayanım özelliği bulunmamaktadır. Apart from the fact that our chemical material cabinets are metal, there is no extra heat/fire resistance feature



Ispanyolet Kilit  
Espagnolette Lock



Kimyasal Galvaniz Tava Raf  
Galvanized Chemical Pan Shelf



Kimyasal Havalandırma  
Chemical Aeration

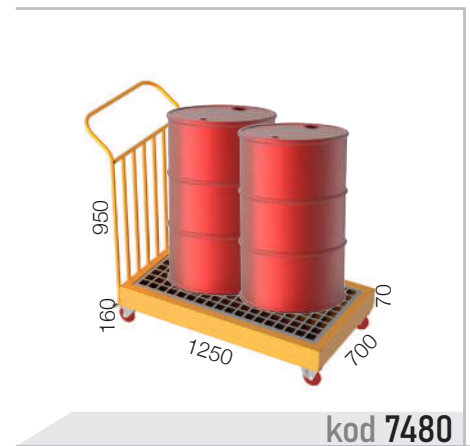
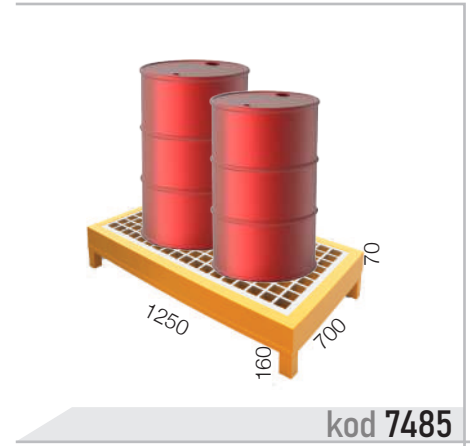



Tüfek namlu aparatı\*  
Rifle Barrel Apparatus\*

Tüfek kabza aparatı\*  
Rifle Grip Apparatus\*

Tabanca aparatı\*  
Gun Apparatus\*

\*Aparatlar dahil değildir, ayrıca ihtiyaca göre sipariş edilir.  
\*Accessories are not included and can be ordered separately if needed.

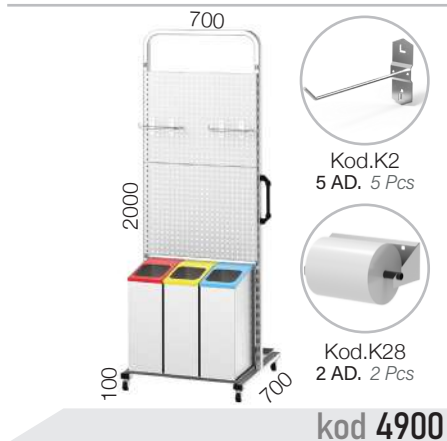



İspanyolet Kilit  
Espagnolette Lock



Rotil Ayak  
Ball Joint Feet

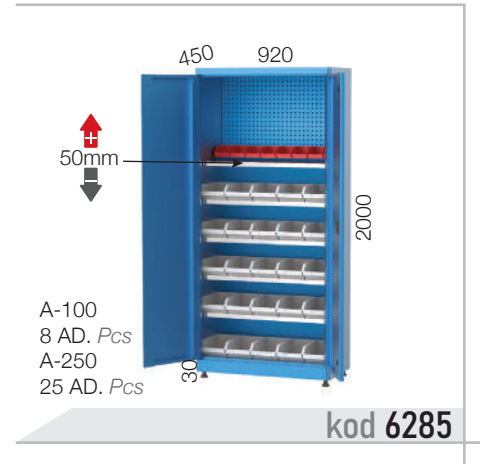
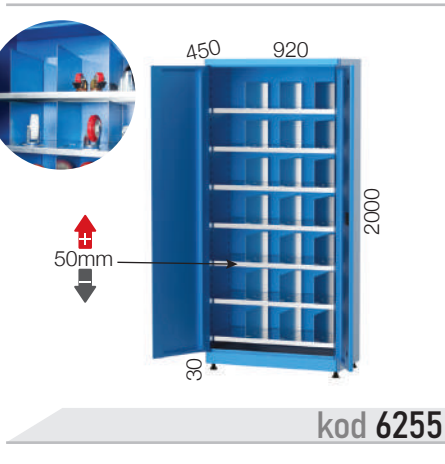



HP4322-AV



A-250



A-150

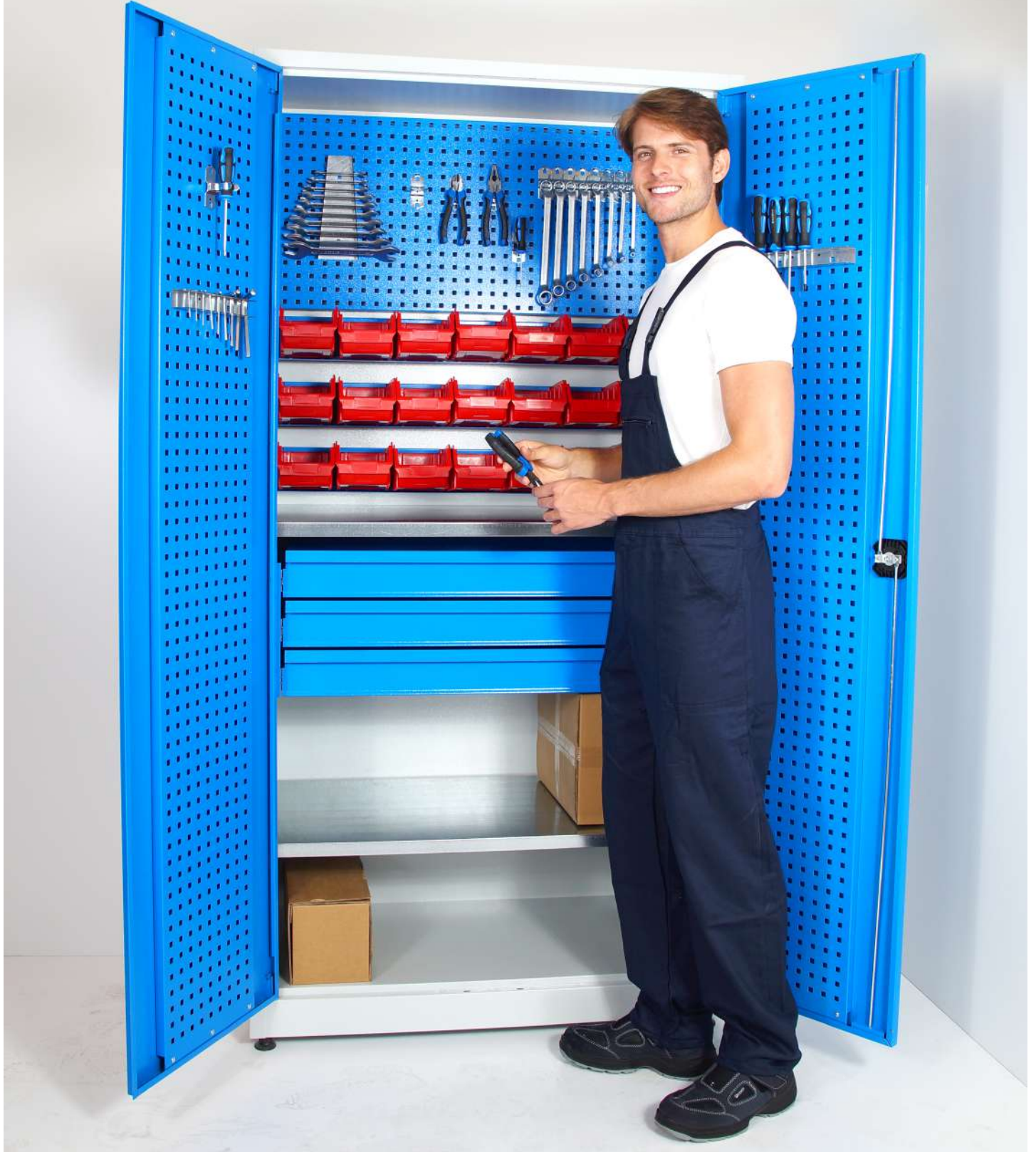

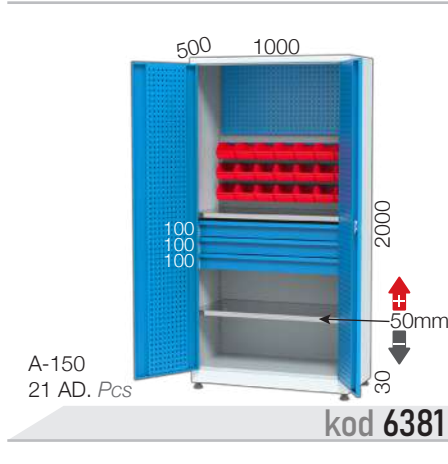

Çekmece taşıma kapasiteleri maksimum 30 kilogramdır. / Drawer carrying capacity is maximum 30 kilograms.



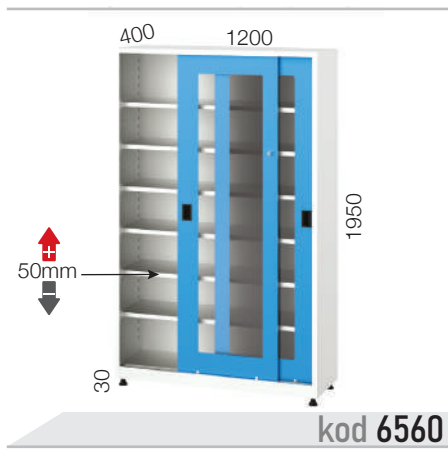
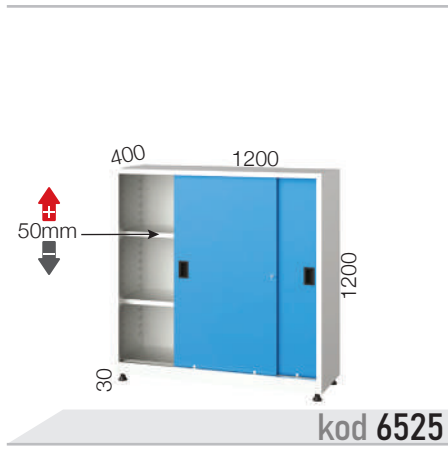
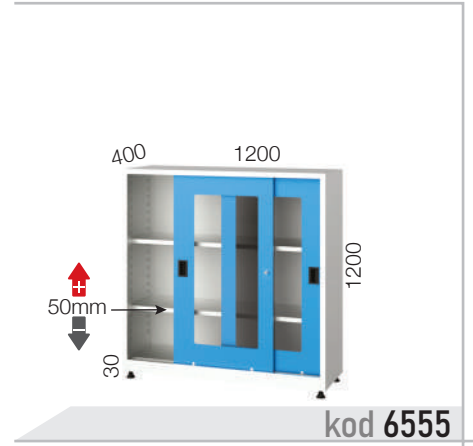



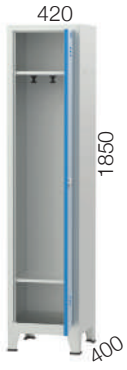

kod 6051



kod 6052



kod 6053

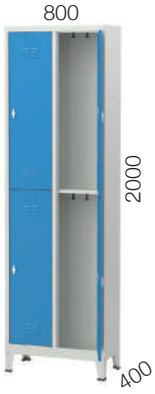

kod 6054



kod 6056



kod 6067

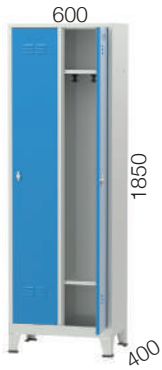

kod 6032



kod 6033



kod 6034



kod 6014



kod 6016



kod 6018



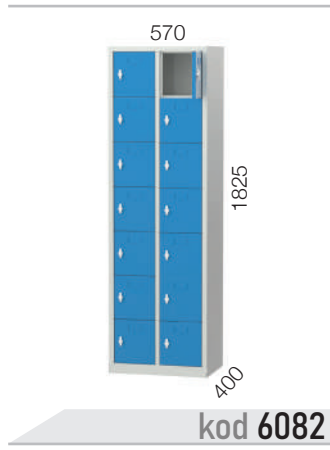
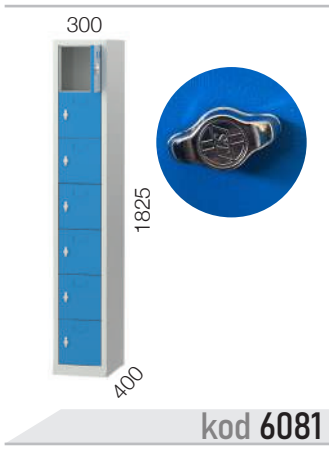
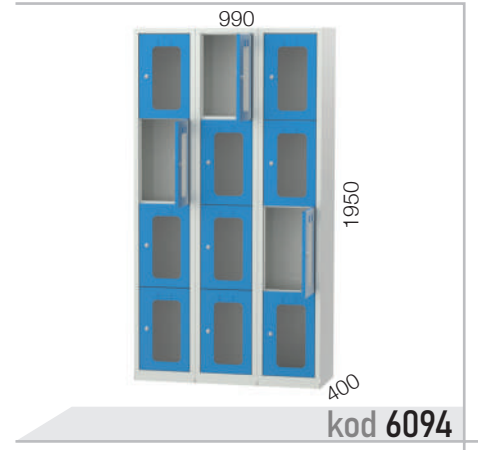
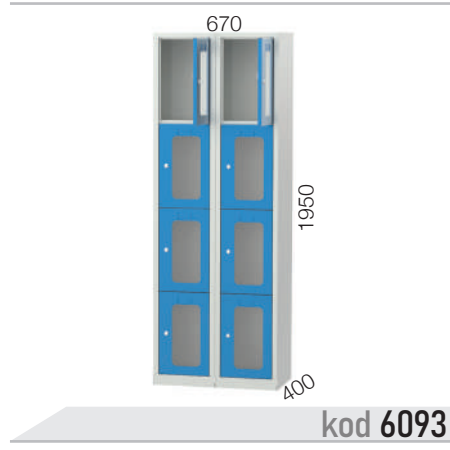
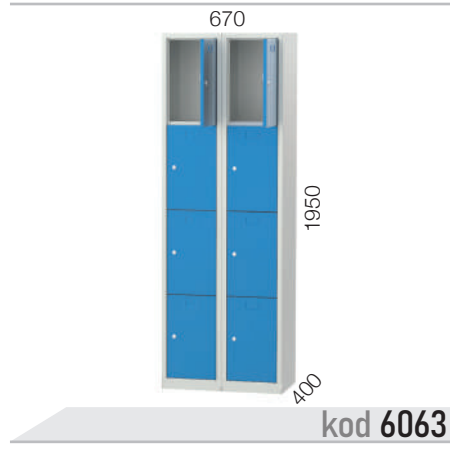
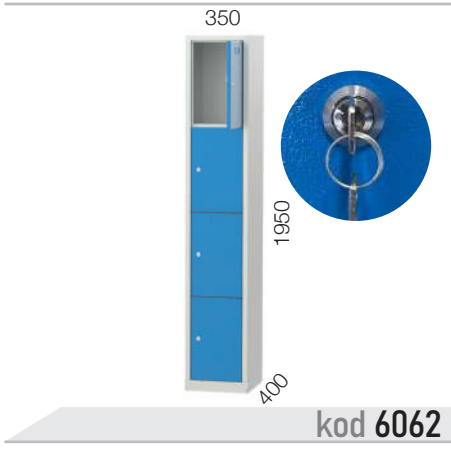
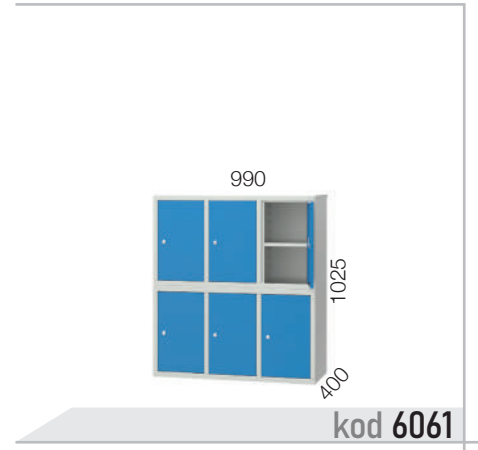



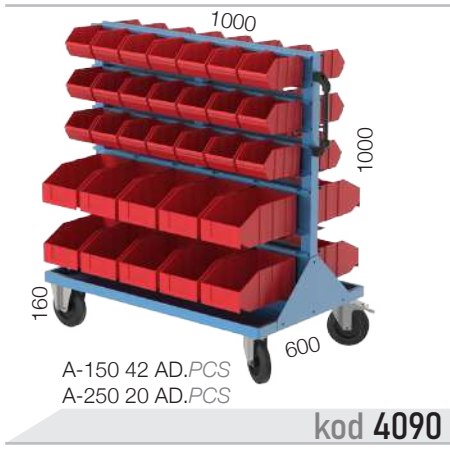
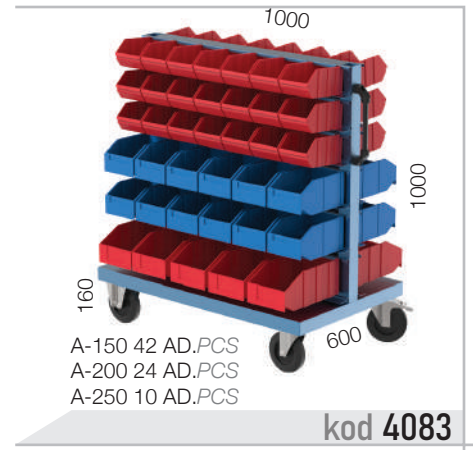
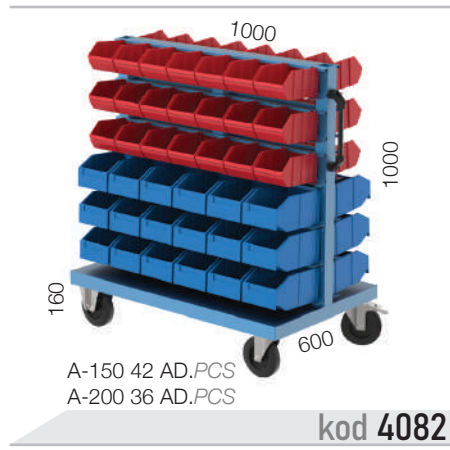
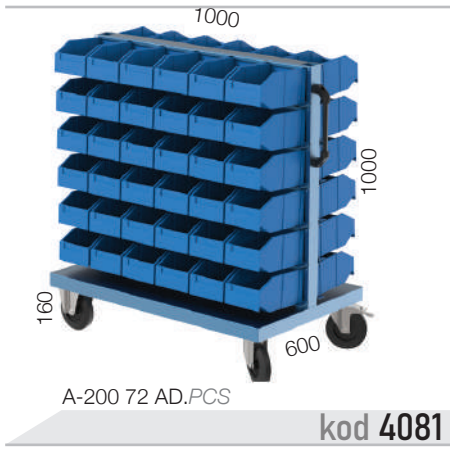
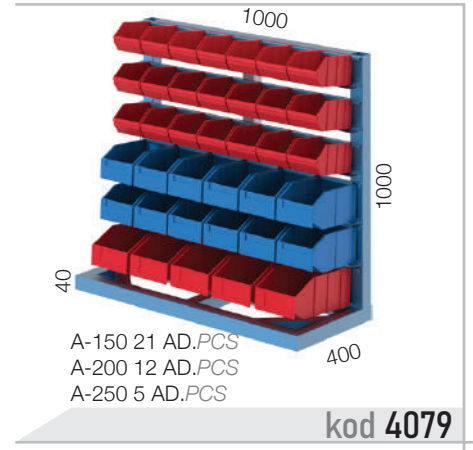
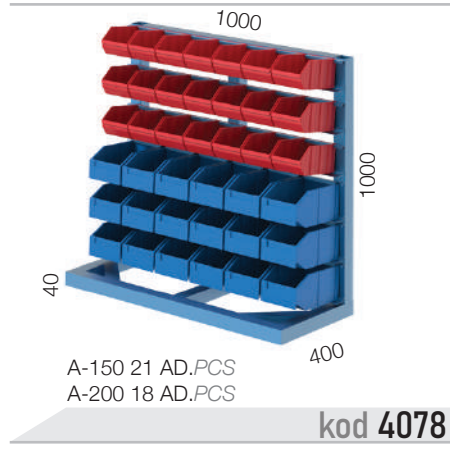
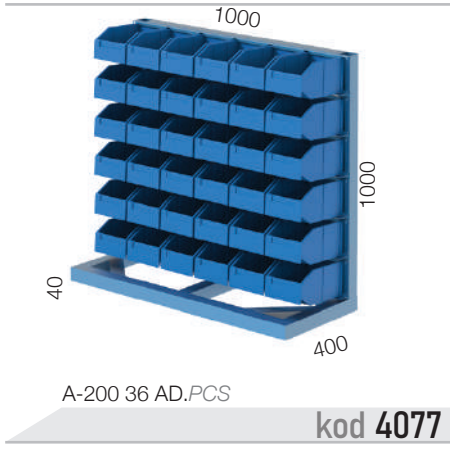

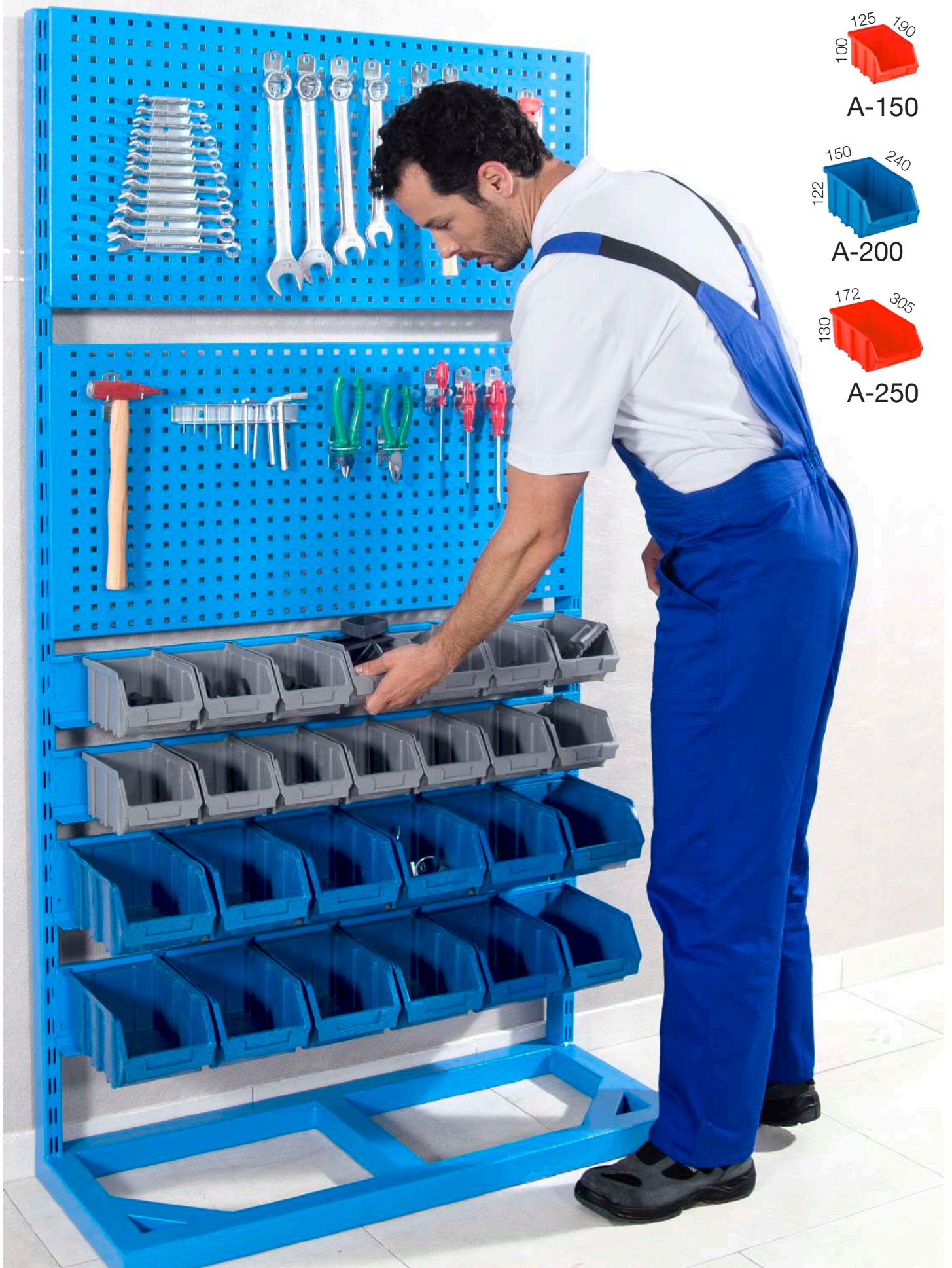

A-150

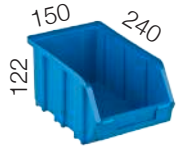

A-200



A-250

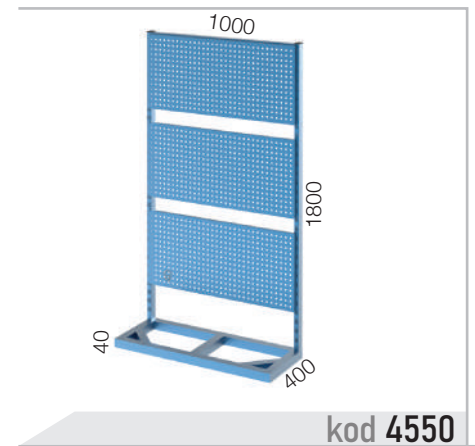
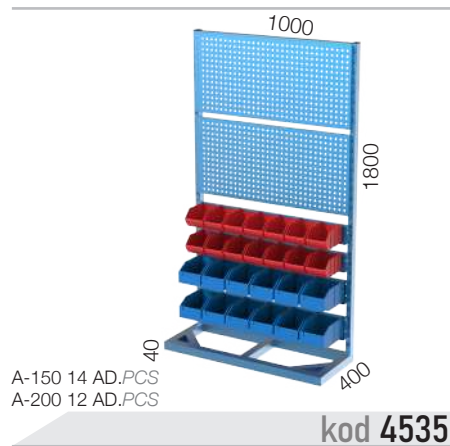
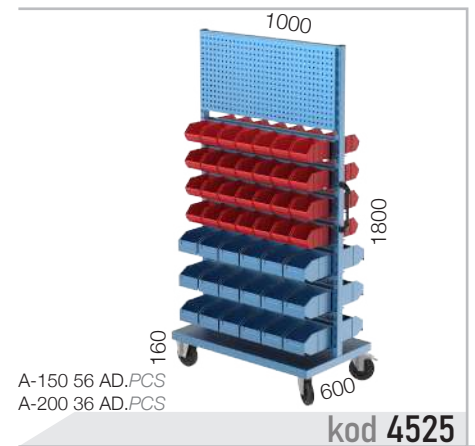
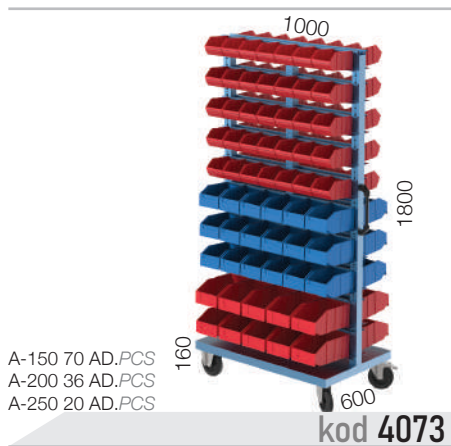
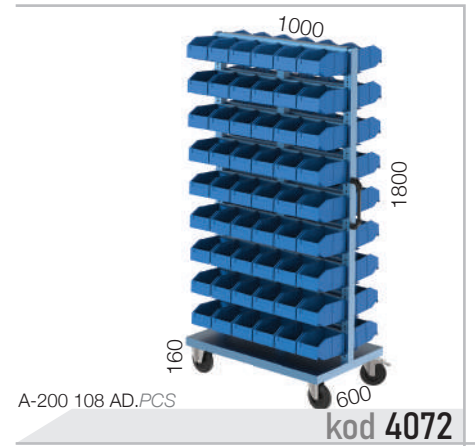
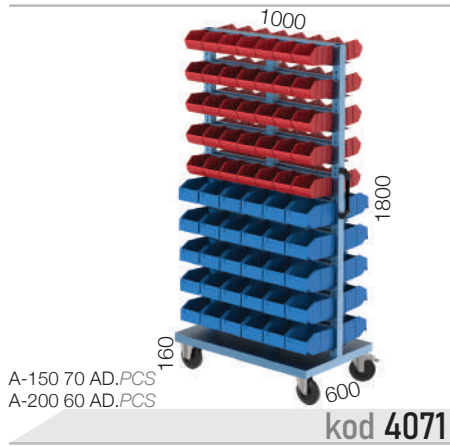
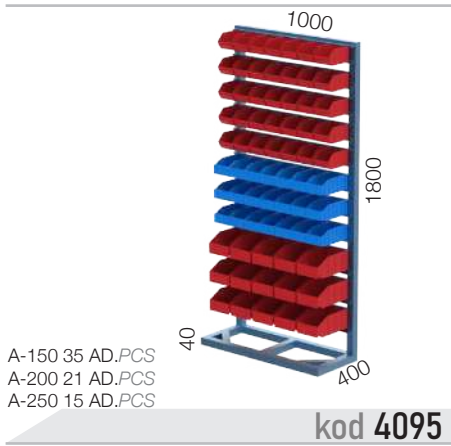
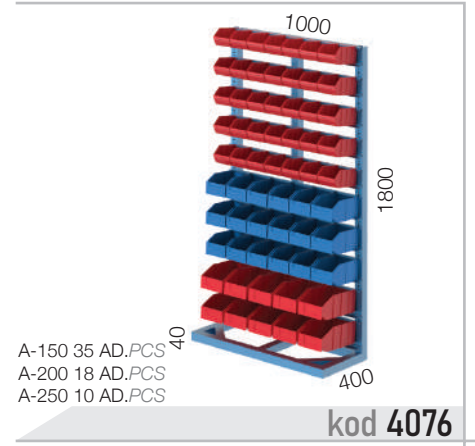
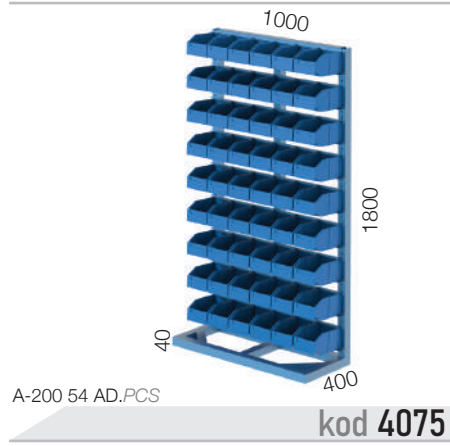
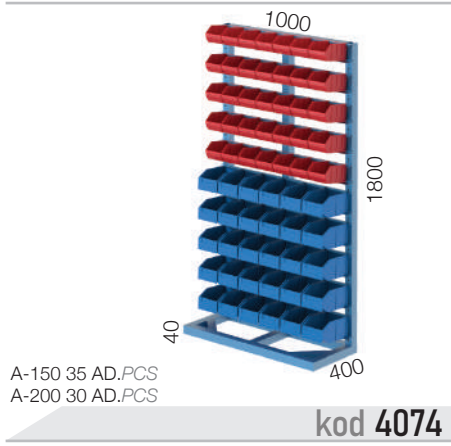

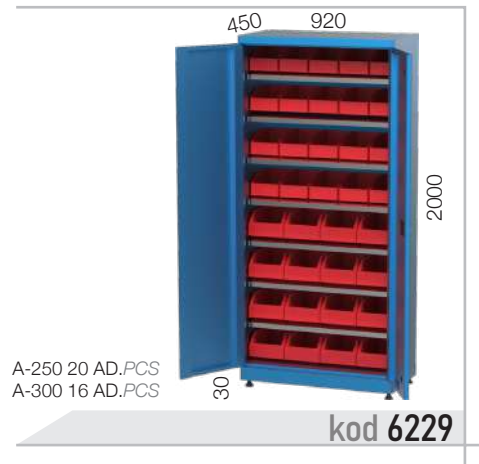
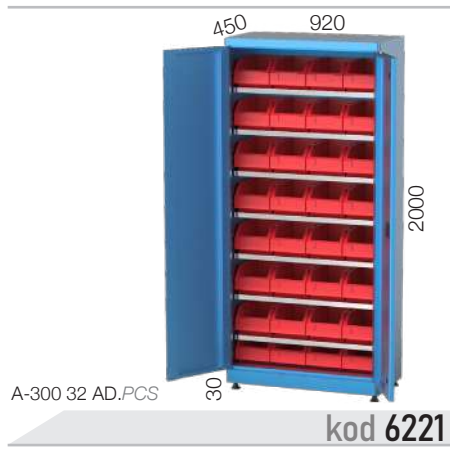





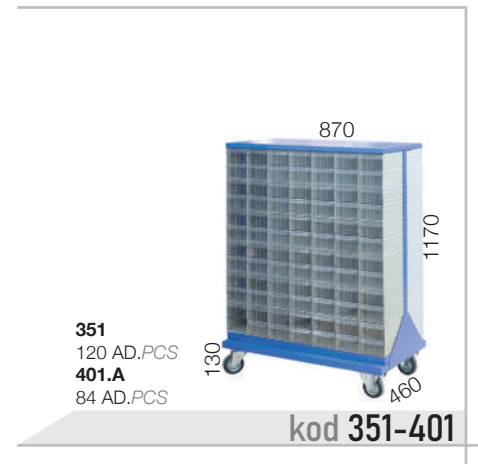
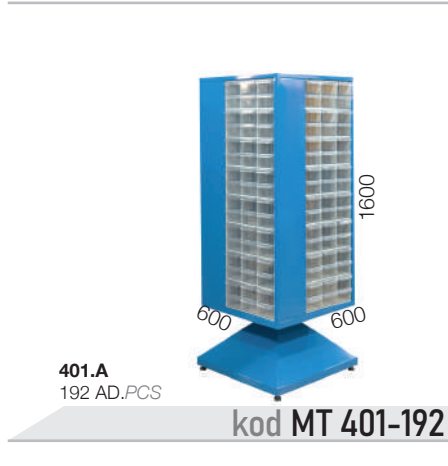
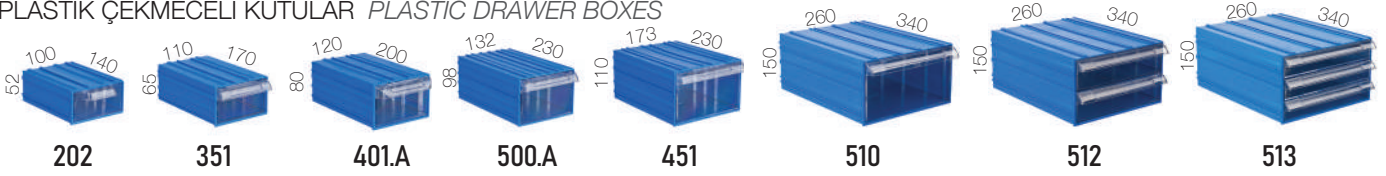



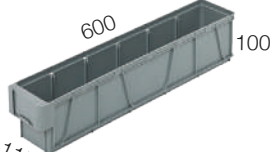

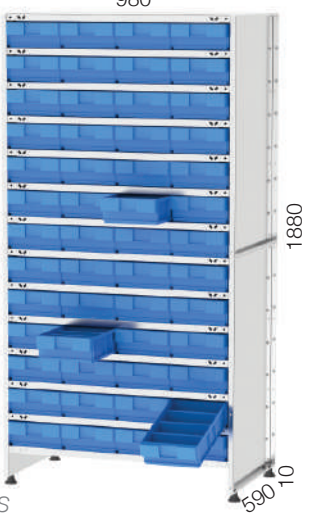
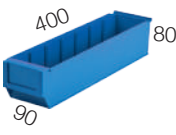
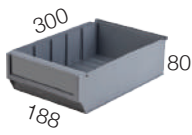

PLASTİK ÇEKMECELİ KUTULAR PLASTIC DRAWER BOXES





 <p><b>kod SV619</b></p>	 <p><b>kod SV609</b></p>	 <p><b>kod SV419</b></p>	 <p><b>kod 592-619</b></p> <p>SV-619 52 AD.PCS SV-619B 260 AD.PCS</p>
 <p><b>kod SV409</b></p>	 <p><b>kod SV319</b></p>	 <p><b>kod SV309</b></p>	
<p>Ara bölme Separator</p>  <p><b>kod SV619 B</b></p>	<p>Ara bölme Separator</p>  <p><b>kod SV609 B</b></p>	<p>Ara bölme Separator</p>  <p><b>kod SV419 B</b></p>	
<p>Ara bölme Separator</p>  <p><b>kod SV409 B</b></p>	<p>Ara bölme Separator</p>  <p><b>kod SV319 B</b></p>	<p>Ara bölme Separator</p>  <p><b>kod SV309 B</b></p>	

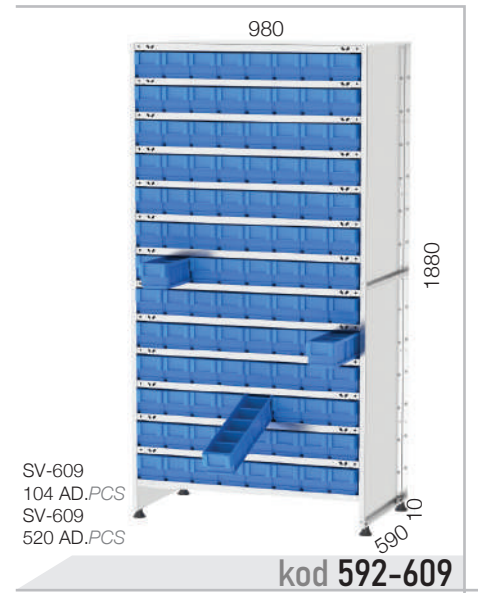
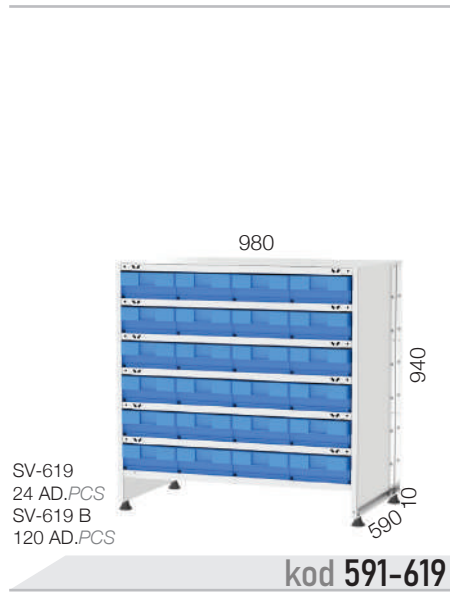
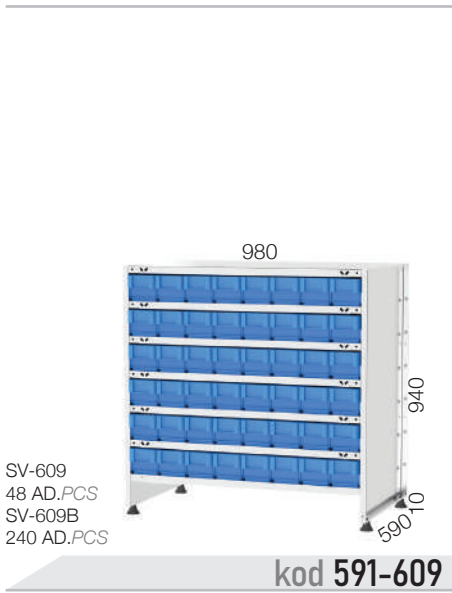
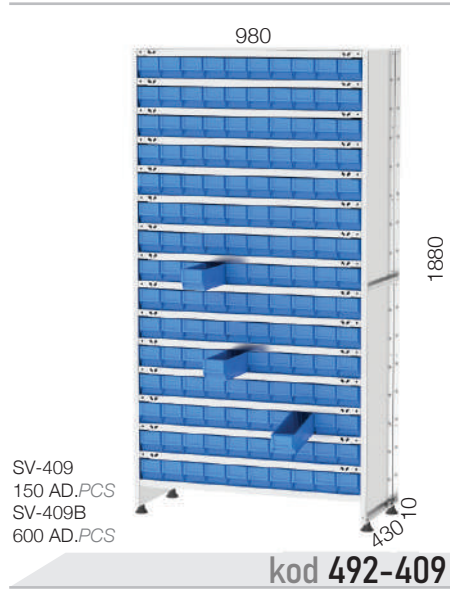
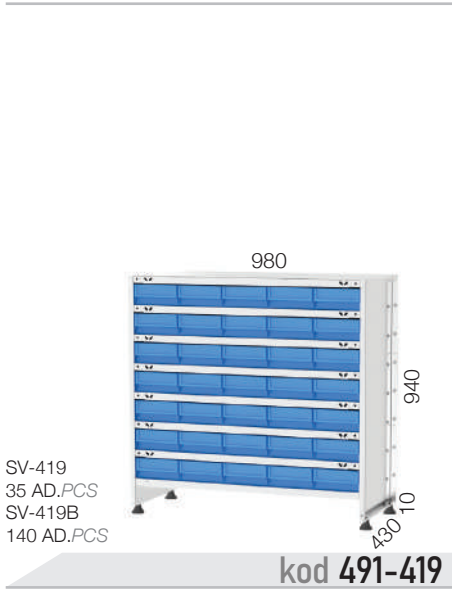
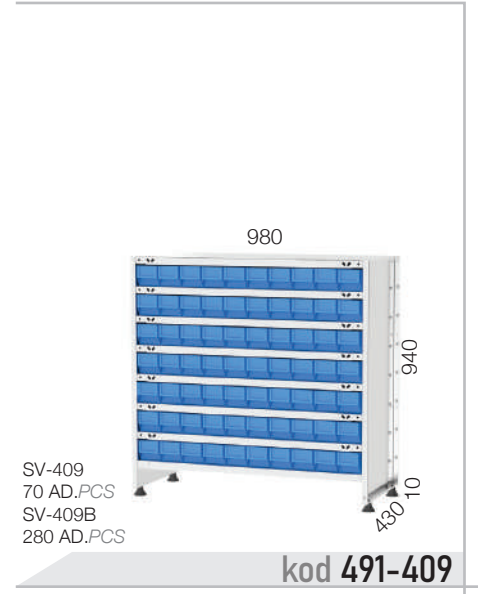
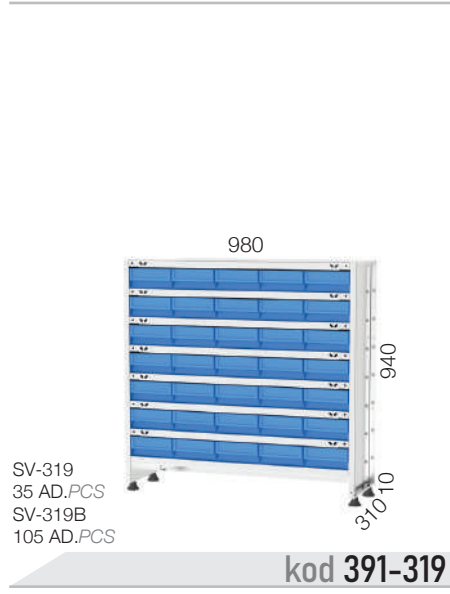
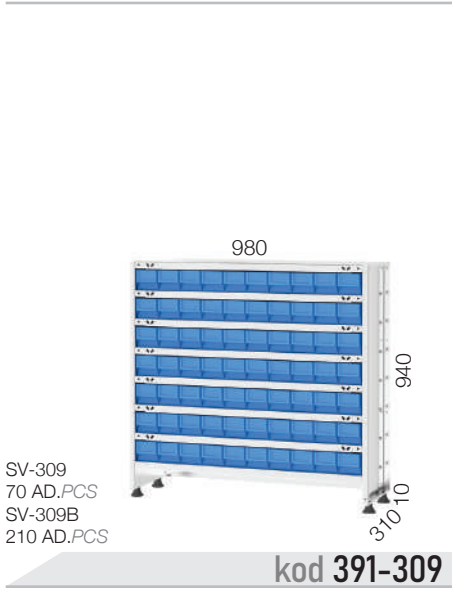



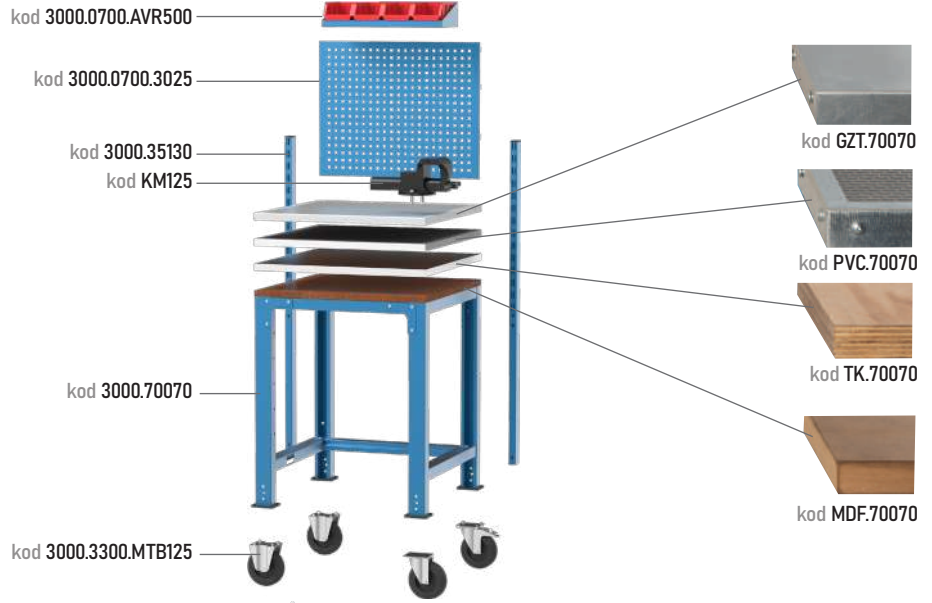

KOCEL®

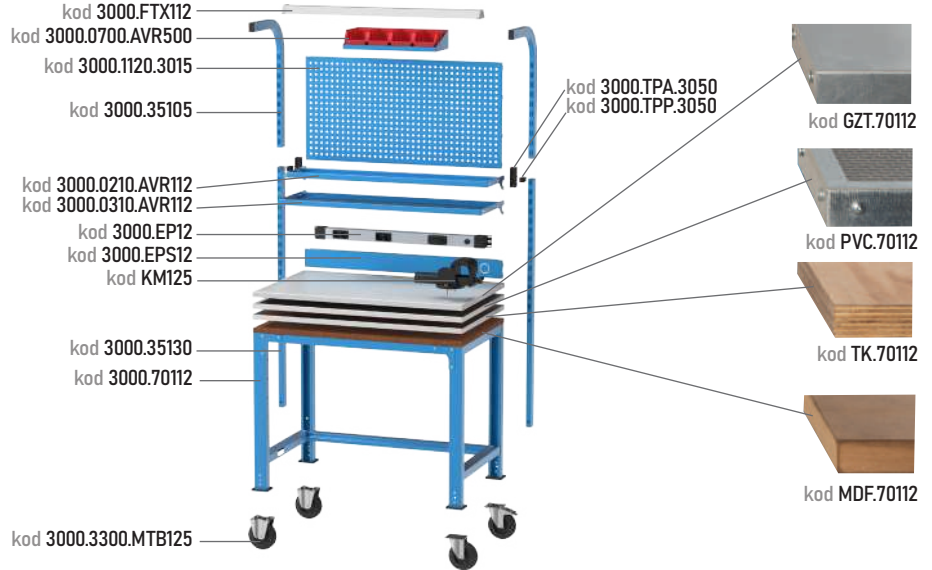

KOCEL®

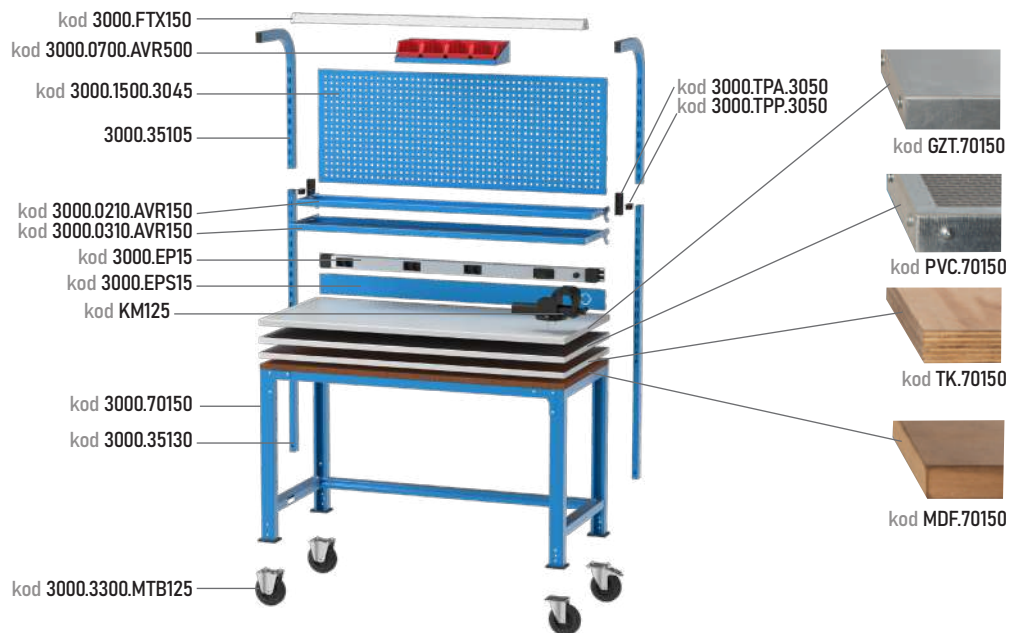

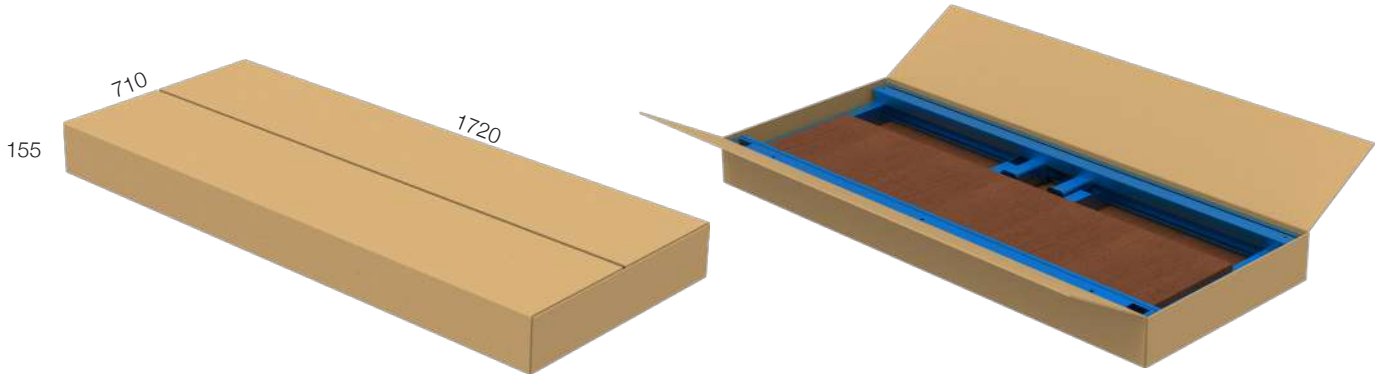
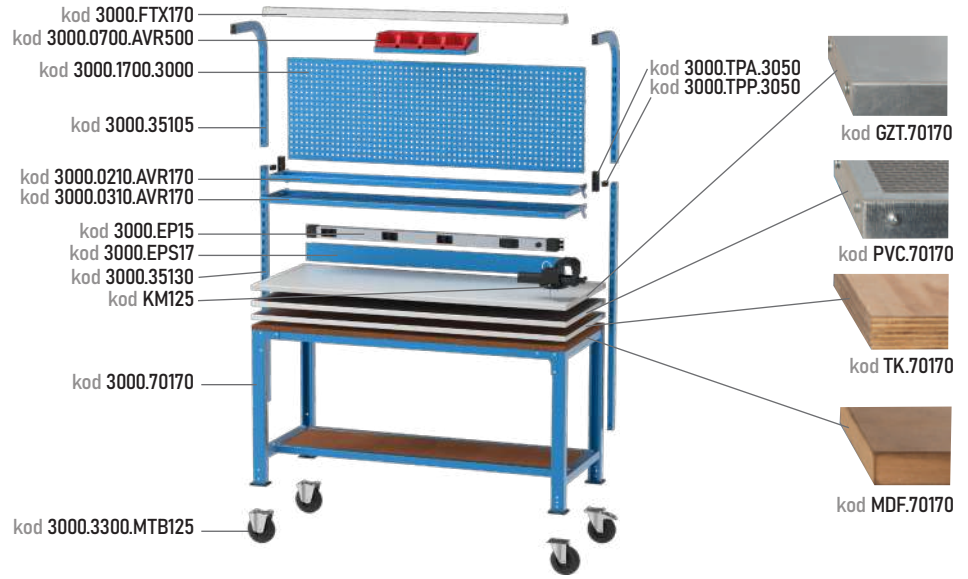

KOCEL®

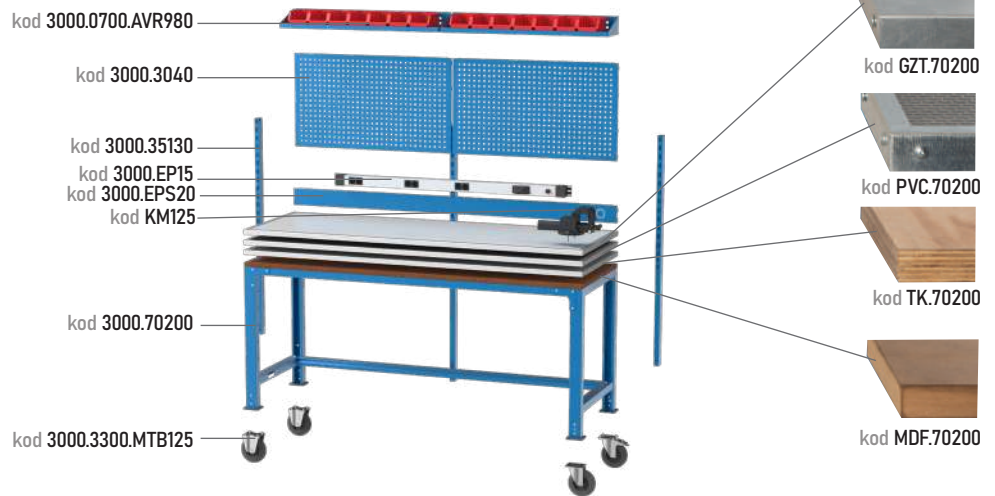

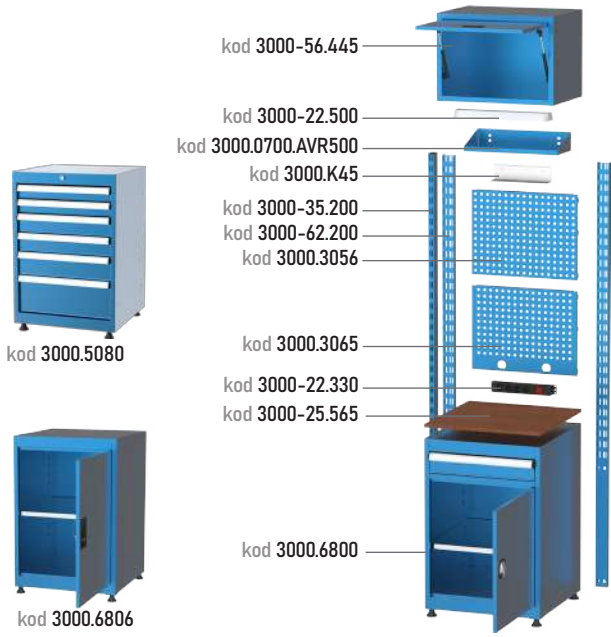

	kod 3000.MDF.5712	kod 3000.MDF.5717	kod 3000.MDF.5722	kod 3000.MDF.5728
	kod 3000.PVC.5712	kod 3000.PVC.5717	kod 3000.PVC.5722	-----
	kod 3000.TK.5712	kod 3000.TK.5717	-----	-----
	kod 3000.GZT.5712	kod 3000.GZT.5717	kod 3000.GZT.5722	-----

KOCEL



	kod 3000.MDF.7214	kod 3000.MDF.7221	kod 3000.MDF.7228
	kod 3000.PVC.7214	kod 3000.PVC.7221	kod 3000.PVC.7228
	kod 3000.TK.7214	kod 3000.TK.7221	-----
	kod 3000.GZT.7214	kod 3000.GZT.7221	-----

KOCEL

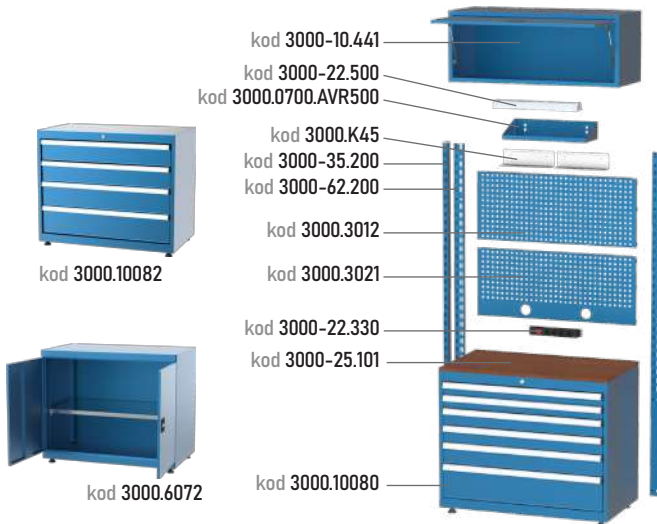

	kod 3000.MDF.5720	kod 3000.MDF.5730
	kod 3000.PVC.5720	kod 3000.PVC.5730
	kod 3000.TK.5720	-----
	kod 3000.GZT.5720	-----

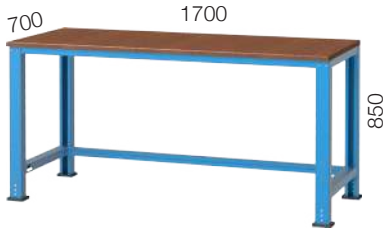

kod 3324

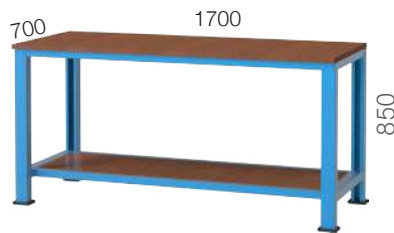

kod 3325

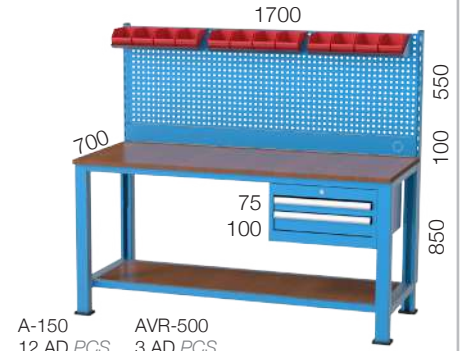

kod 3700

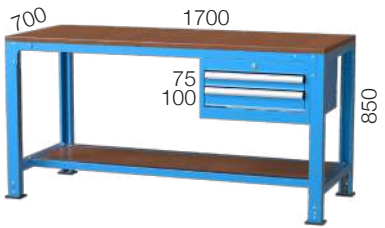

kod 3704

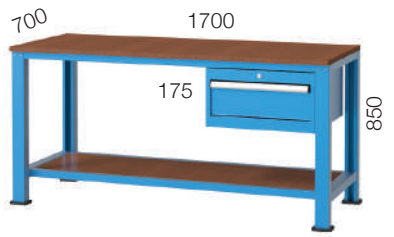

kod 3745

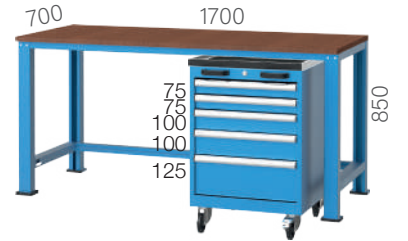

kod 3330

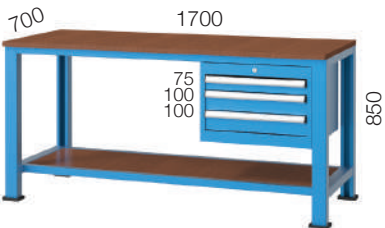

kod 3710

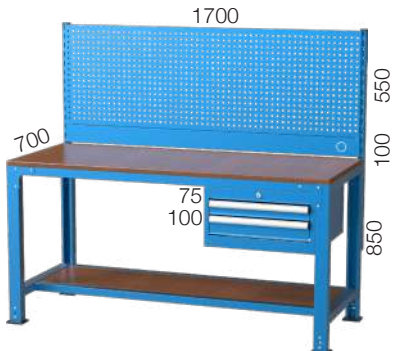

kod 3714

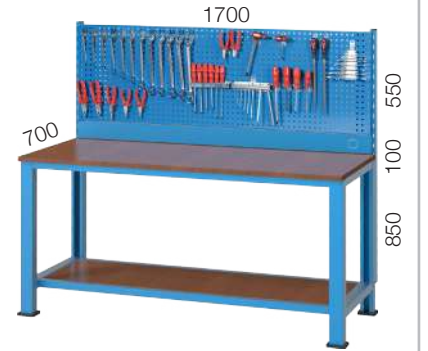

kod 3750

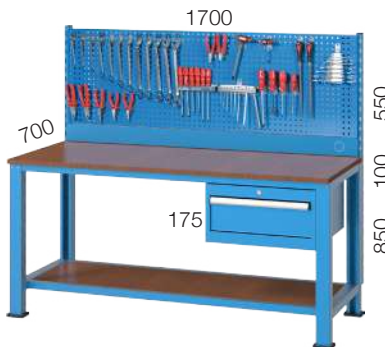

kod 3755

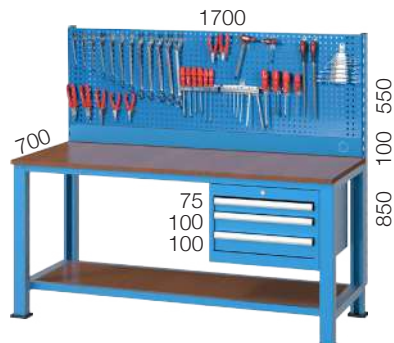

kod 3740

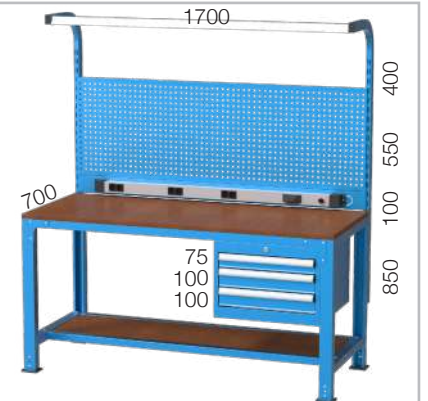

kod 3770

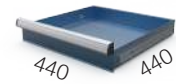
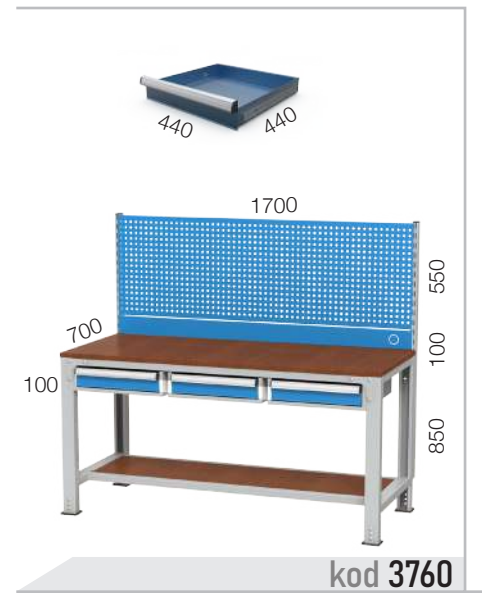
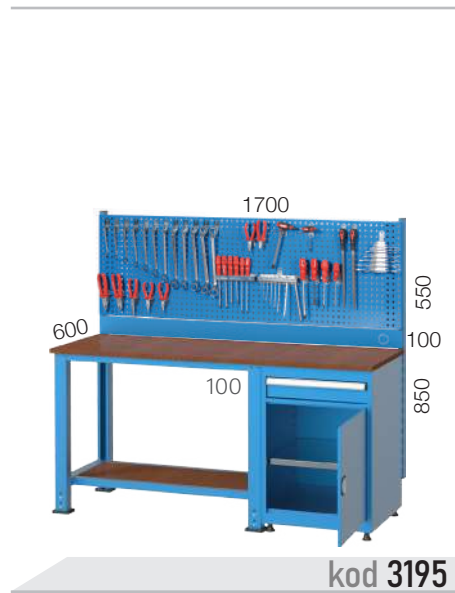
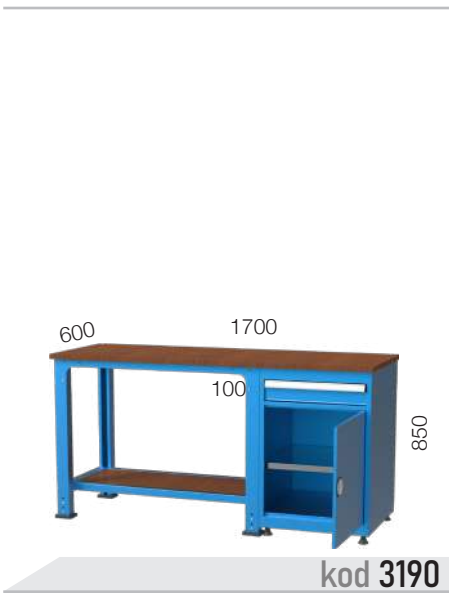
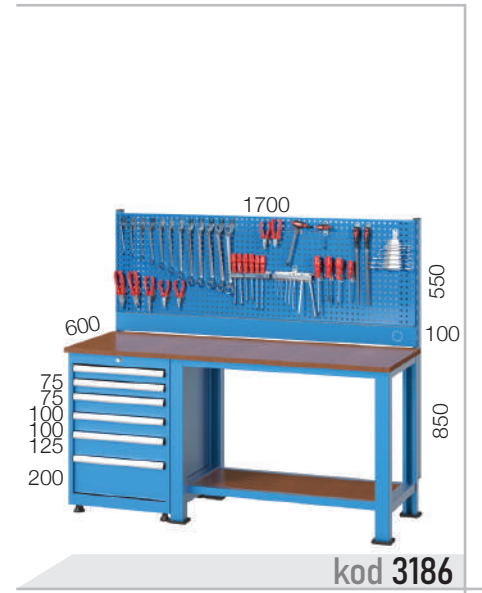
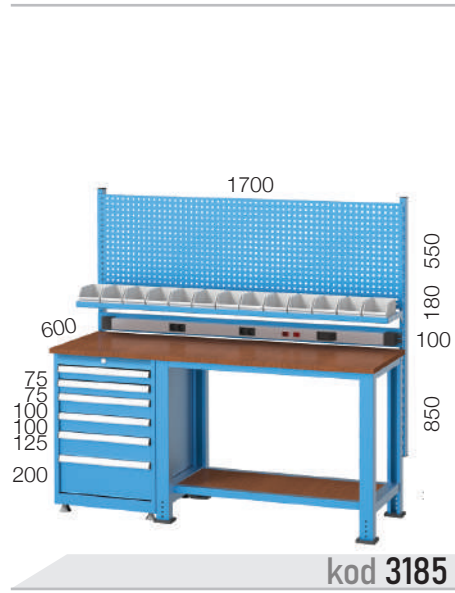
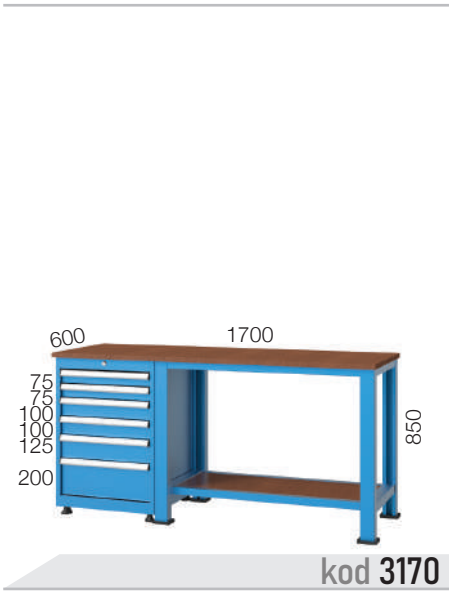
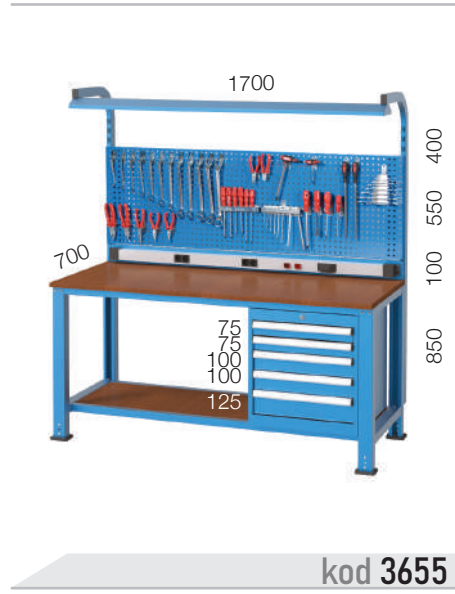
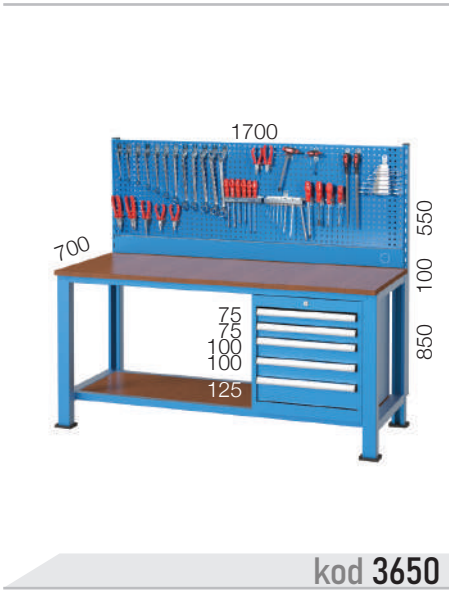

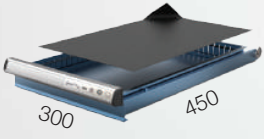

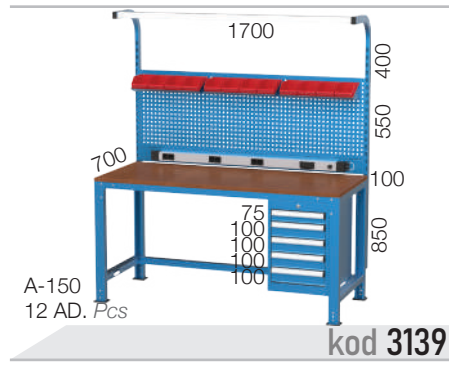
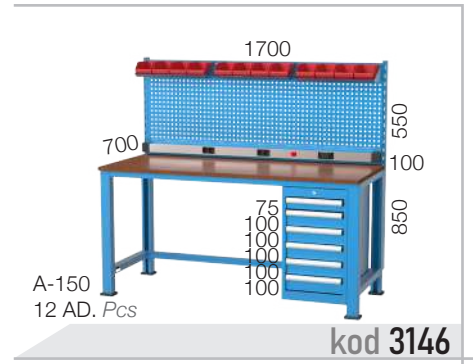
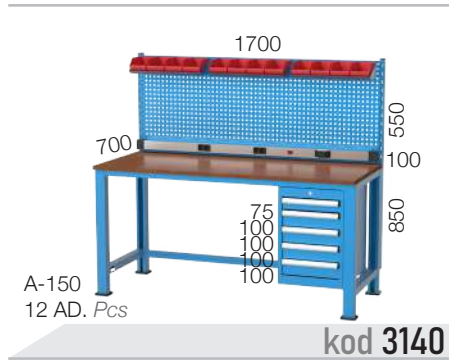
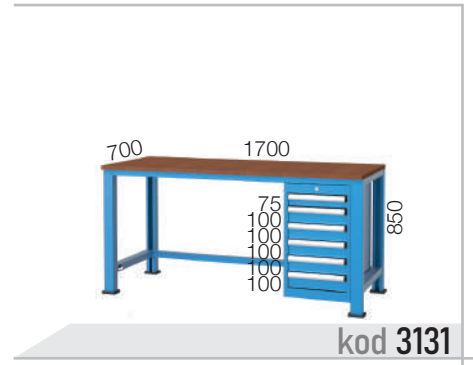
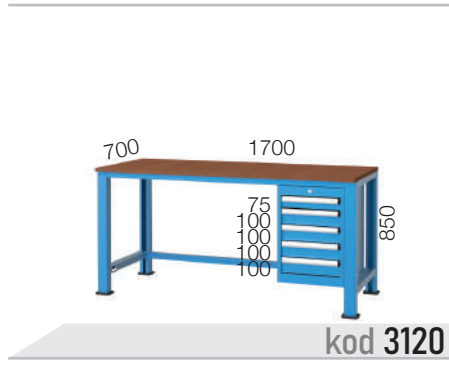
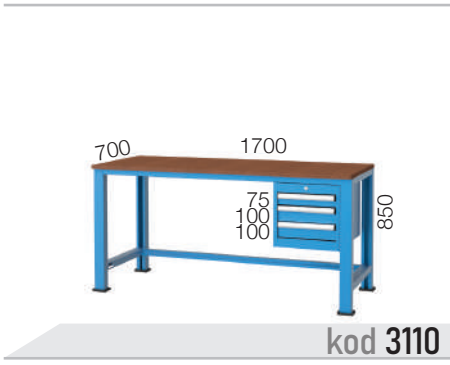
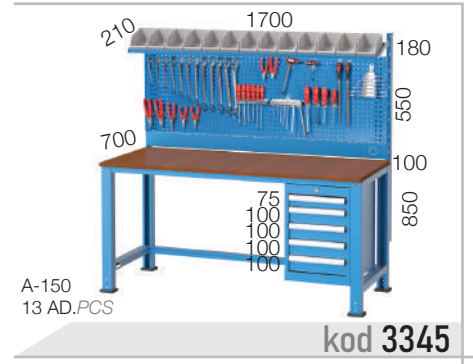
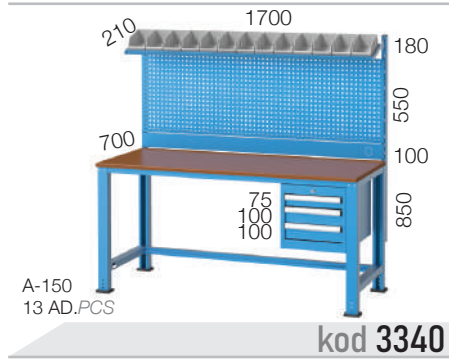
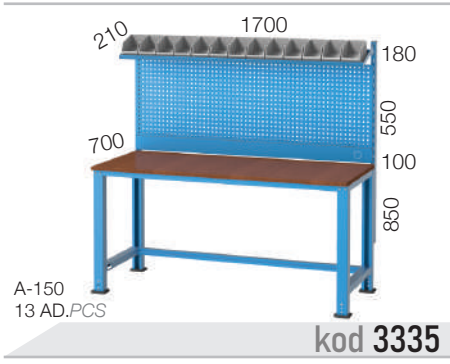
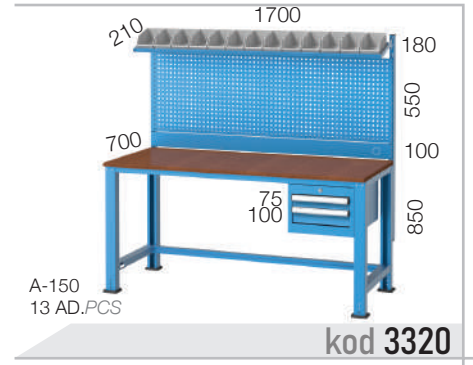
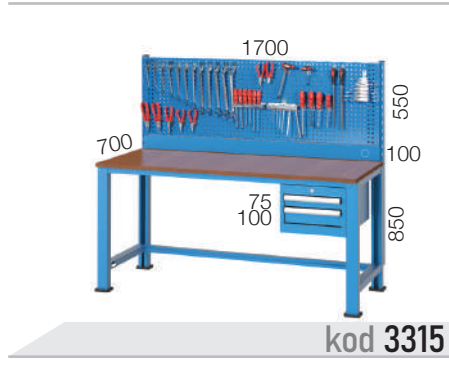
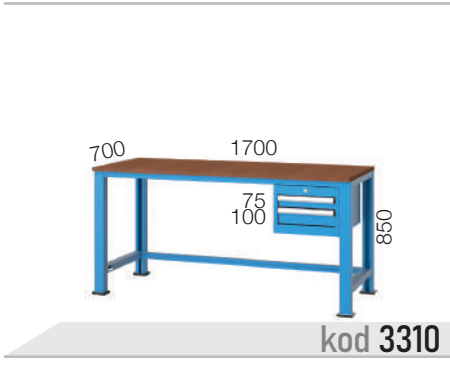



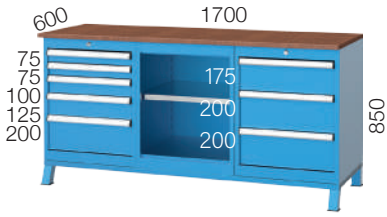

kod 3600



kod 3605



kod 3610



kod 3625

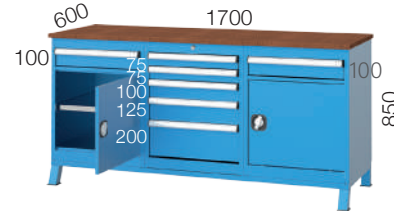

kod 3622

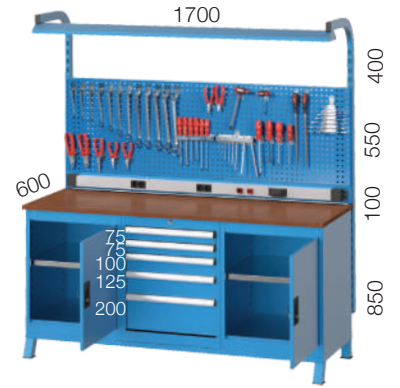

kod 3602

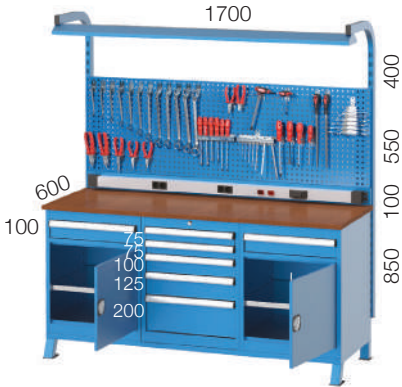

kod 3606

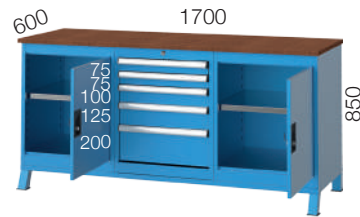

kod 3621



kod 3540



kod 3590

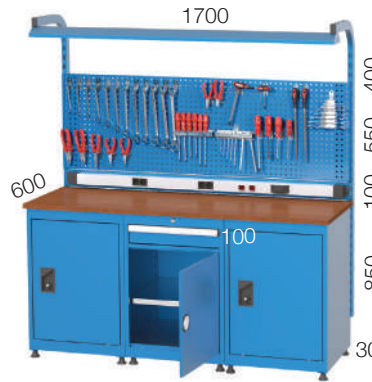

kod 3595



kod 3596



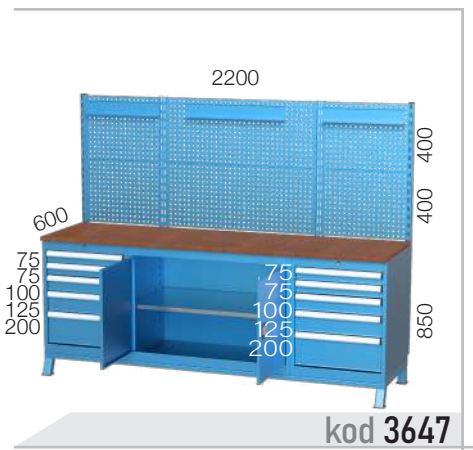
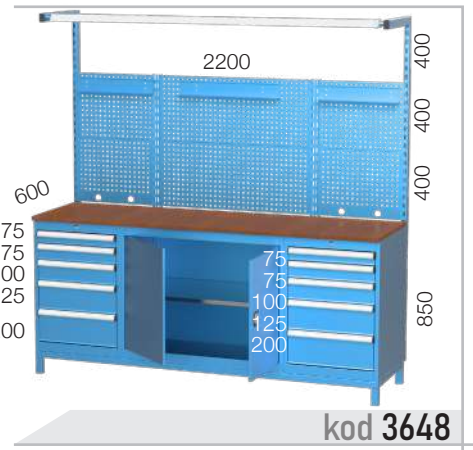
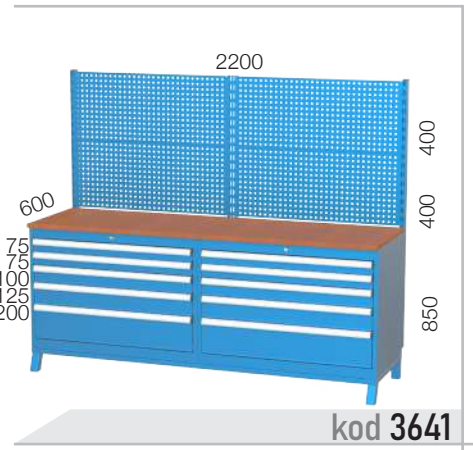
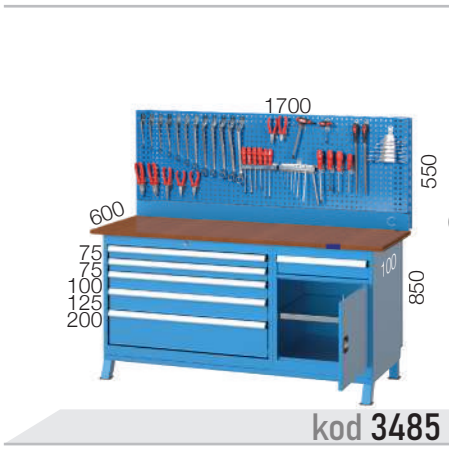
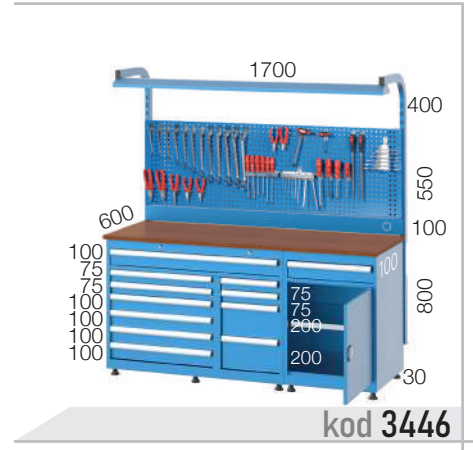
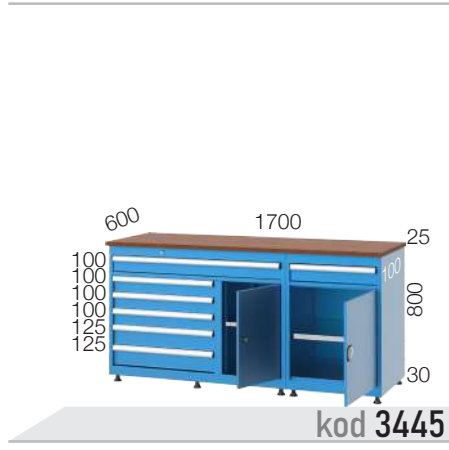
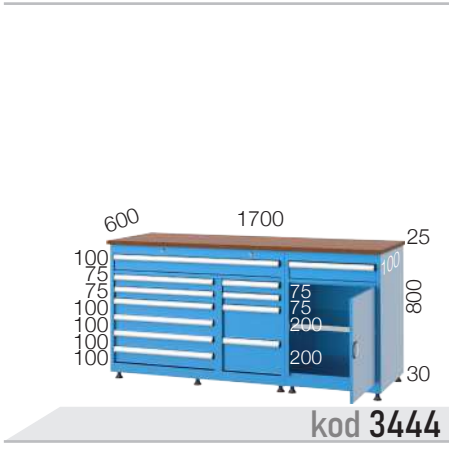

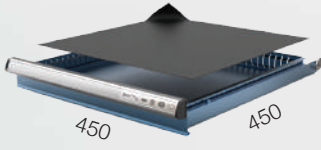



kod 3431

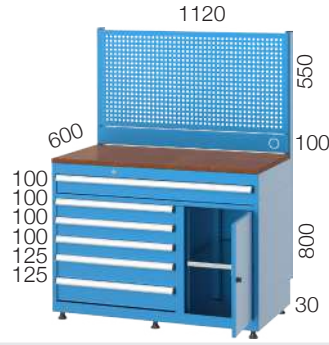

kod 3432



kod 3465



kod 3460



kod 3917



kod 3461



kod 3919



kod 3921



kod 3922



A-150  
8 AD. Pcs

kod 3923





kod 3360

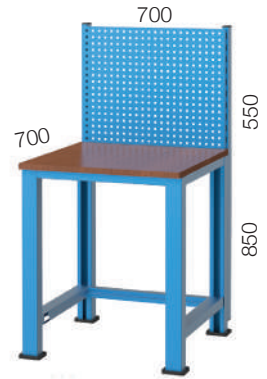

kod 3365



kod 3390



kod 3370



kod 3375

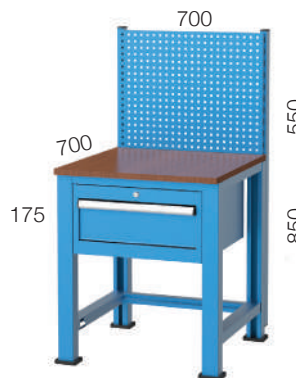

kod 3380

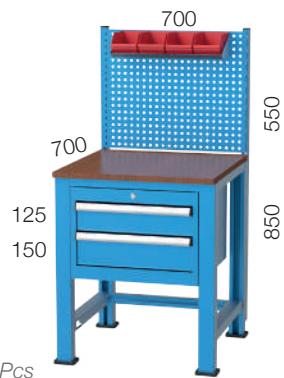

A-150  
4 AD. Pcs

kod 3385

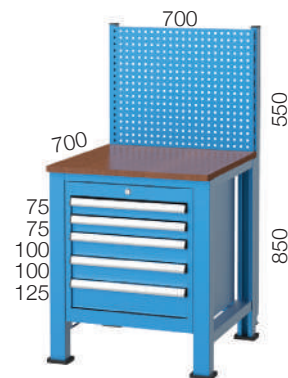

kod 3395



kod 3936

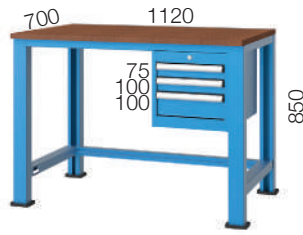
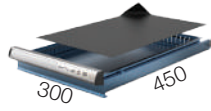

kod 3937



kod 3941

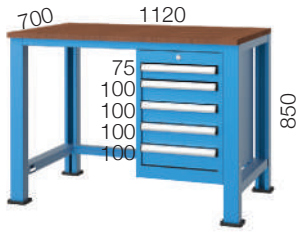

kod 3943

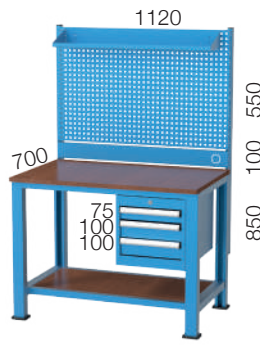

kod 3942

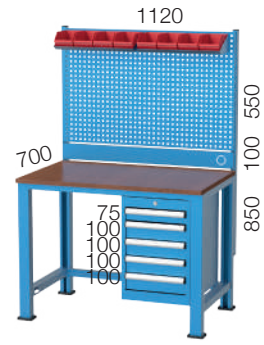

kod 3944

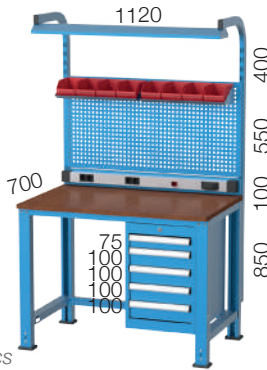

A-150  
8 AD. Pcs

kod 3945



A-150  
8 AD. Pcs

kod 3947

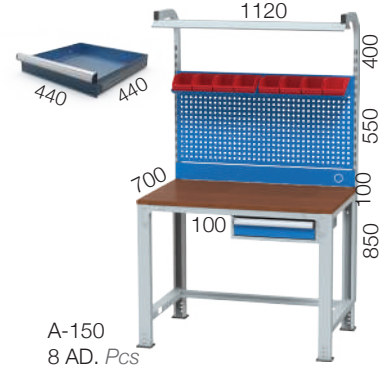

A-150  
8 AD. Pcs

kod 3949

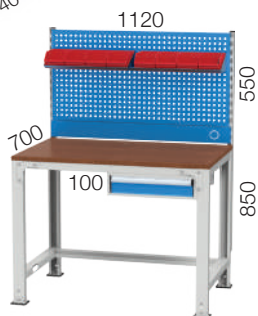

A-150  
8 AD. Pcs

kod 3948

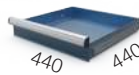

kod 3927

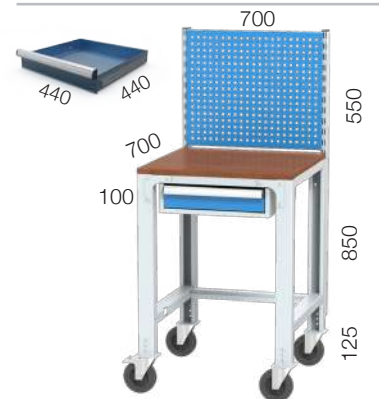

kod 3381

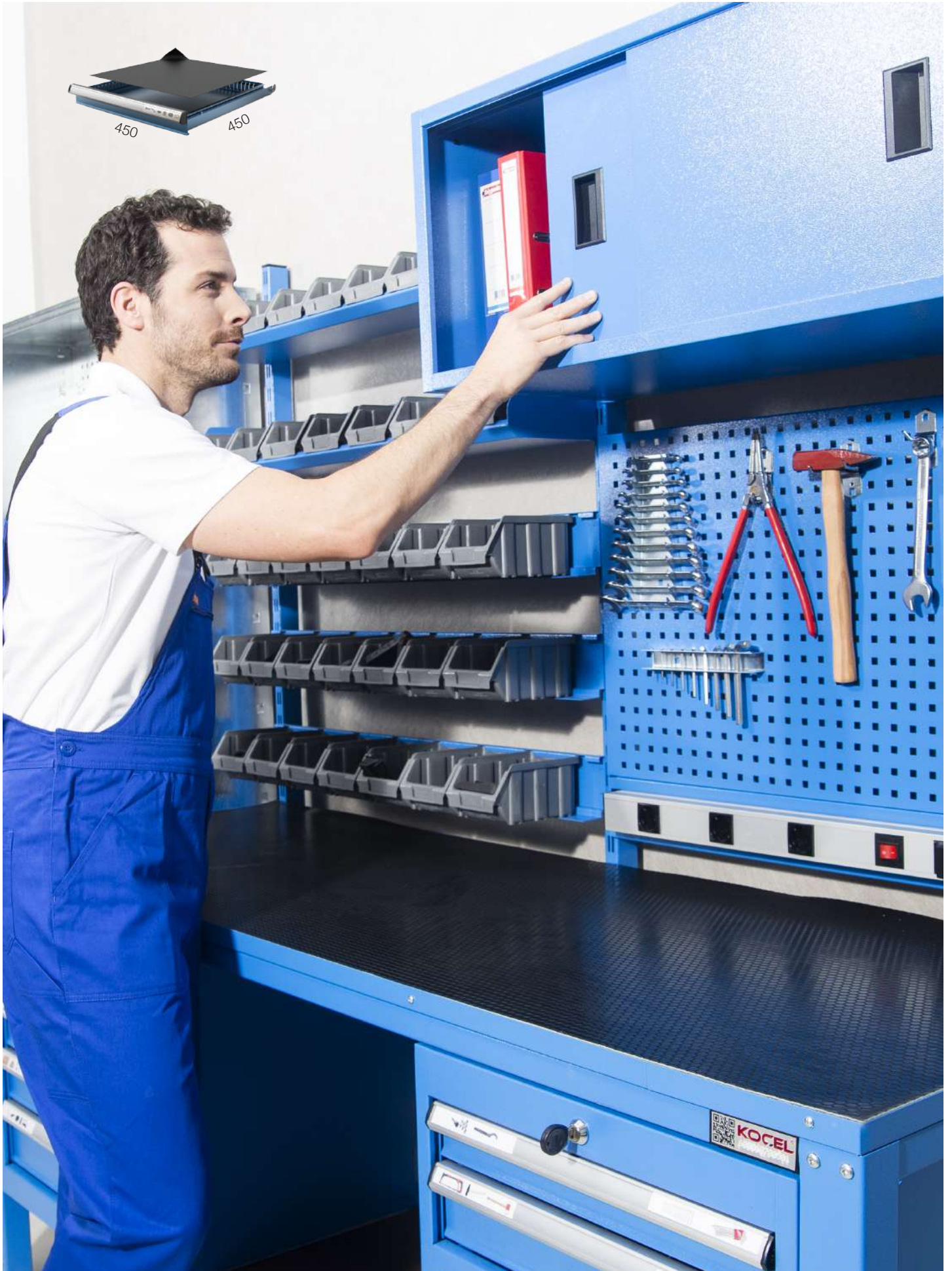

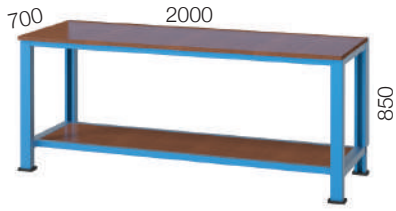

kod 3211

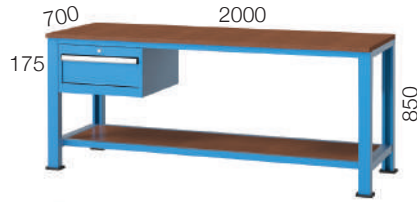

kod 3214



kod 3210

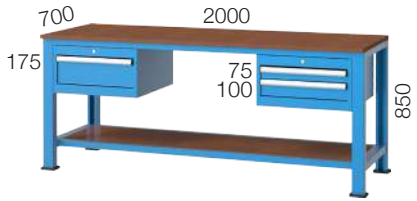

kod 3215

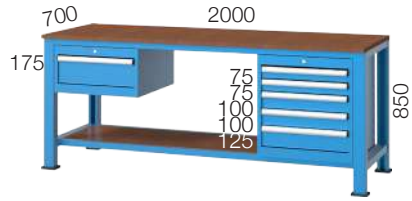

kod 3220

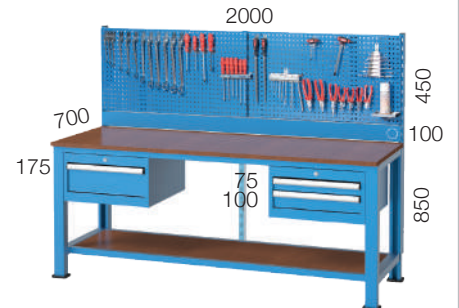

kod 3205

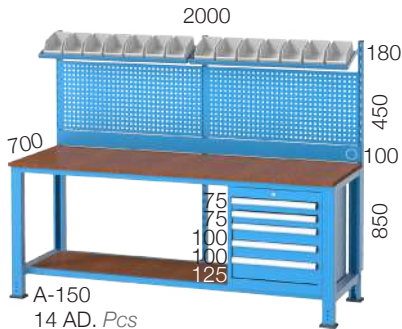

kod 3260

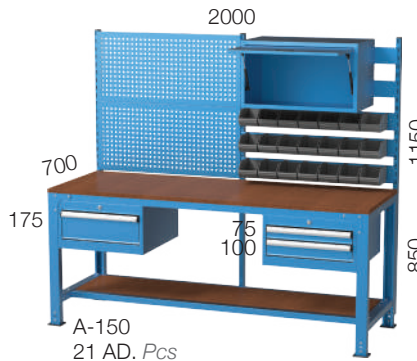

kod 3265

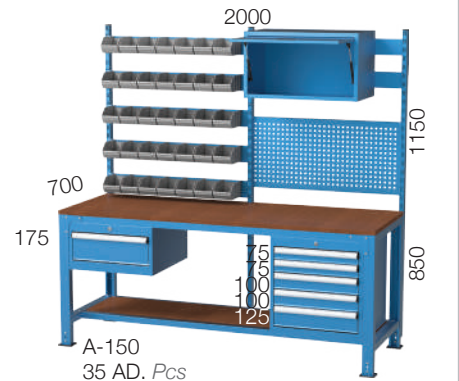

kod 3270



kod 3275

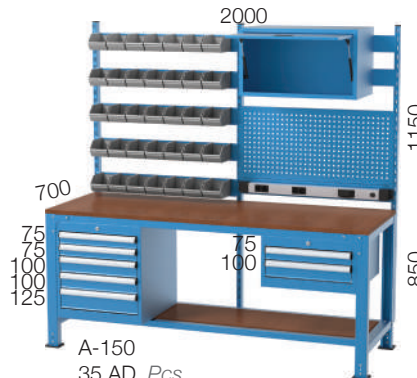

kod 3280

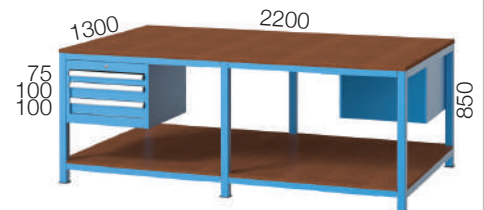

kod 3350





kod 3781



kod 3782



kod 3783

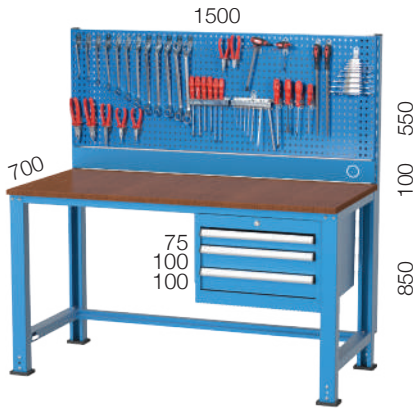

kod 3784

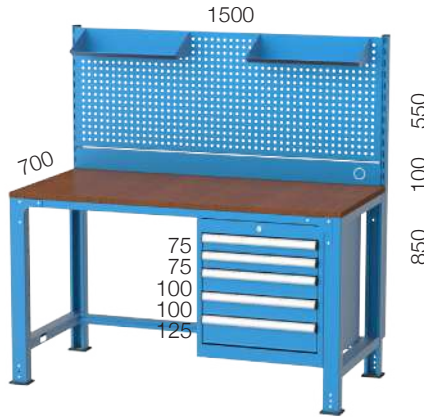

kod 3785

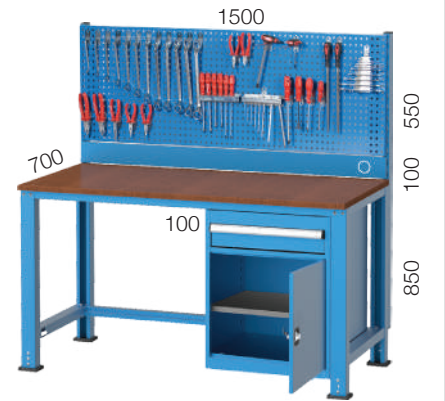

kod 3786



kod 3787



kod 3788

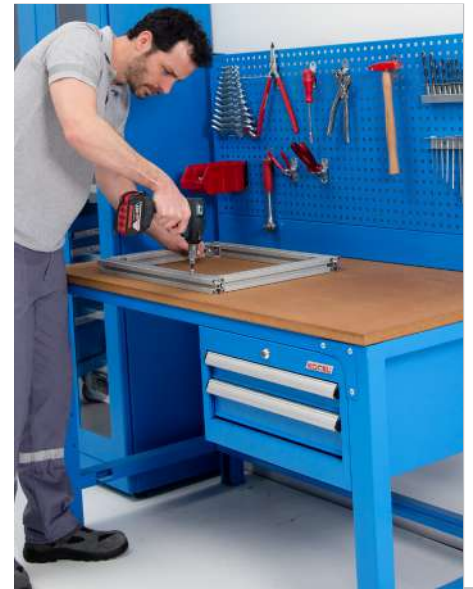



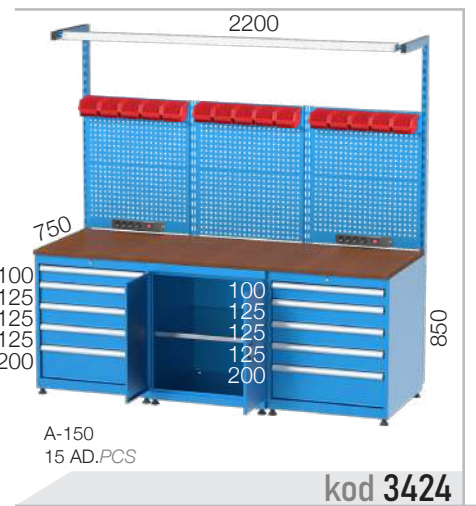
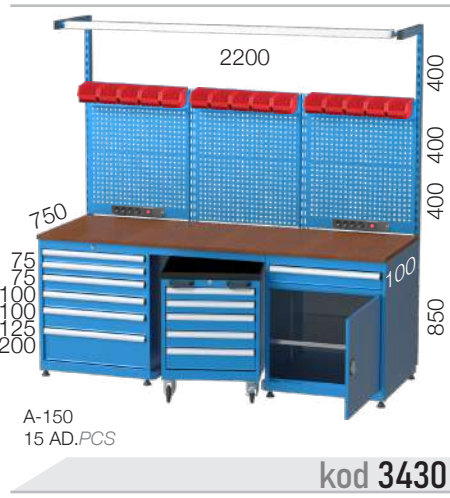
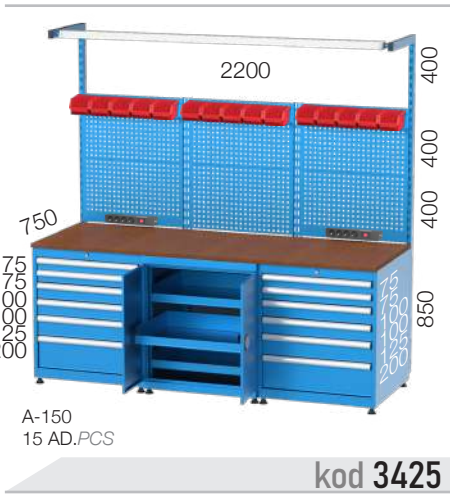
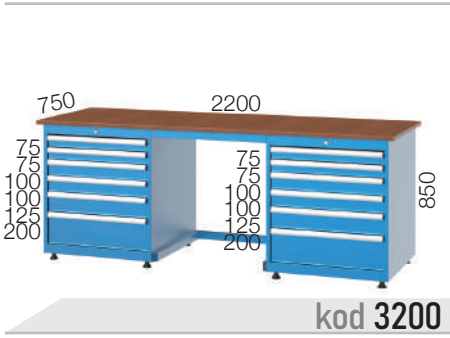
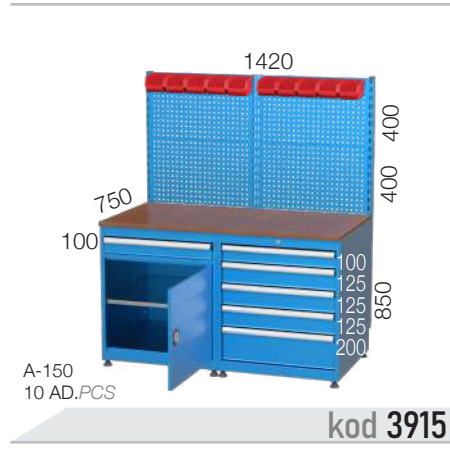



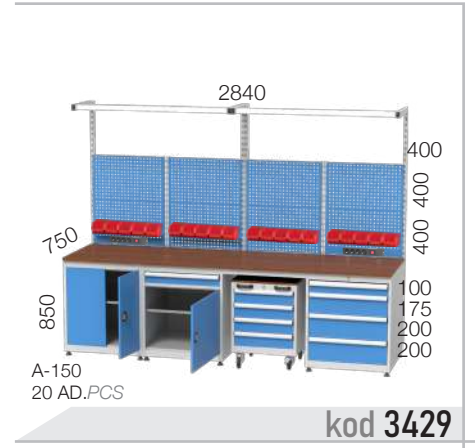





kod 3661

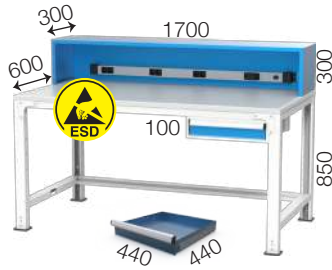

kod 3662



kod 3663

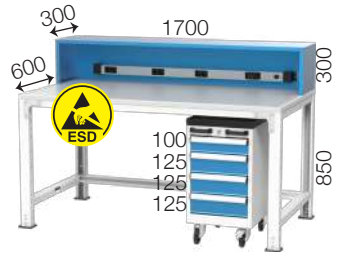

kod 3664



kod 3651

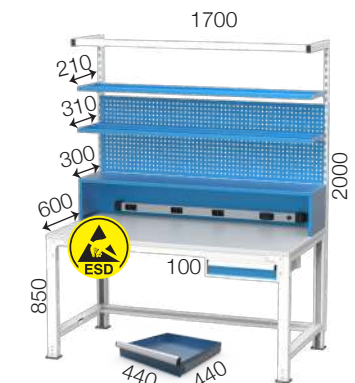

kod 3652



kod 3653

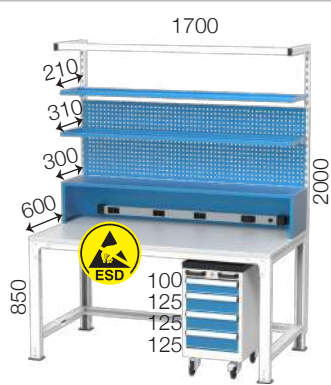

kod 3654

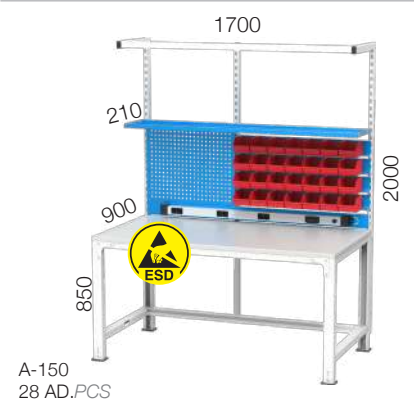

A-150  
28 AD.PCS

kod 3656

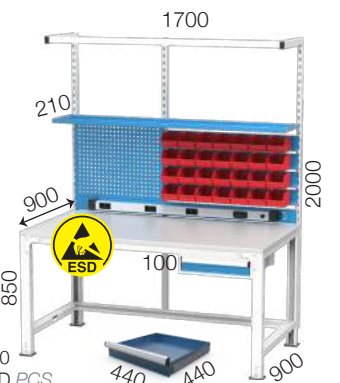

A-150  
28 AD.PCS

kod 3657

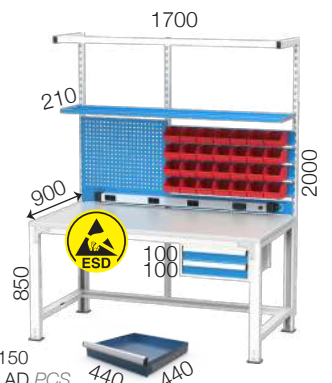

A-150  
28 AD.PCS

kod 3658

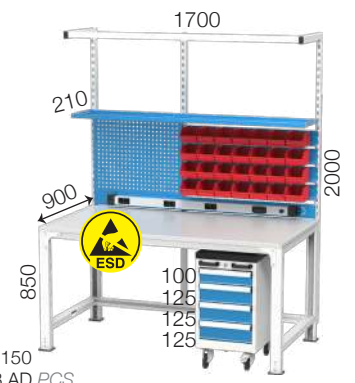

A-150  
28 AD.PCS

kod 3659

27x27 E



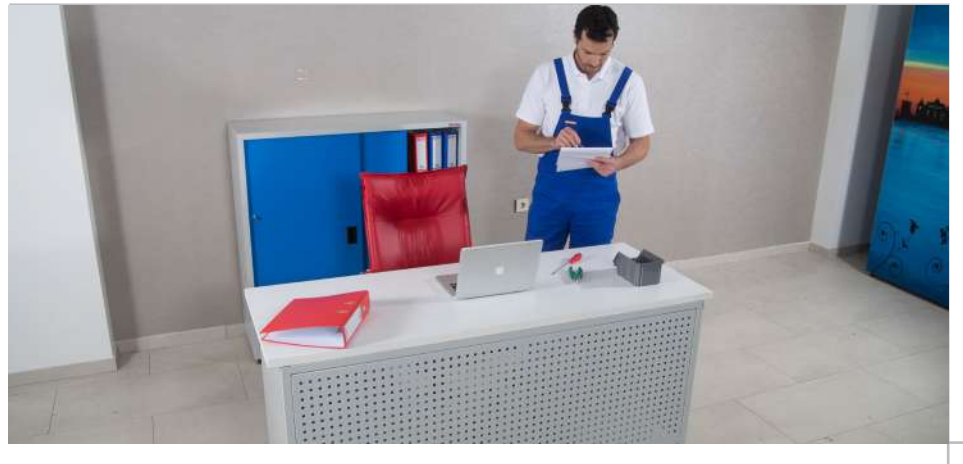
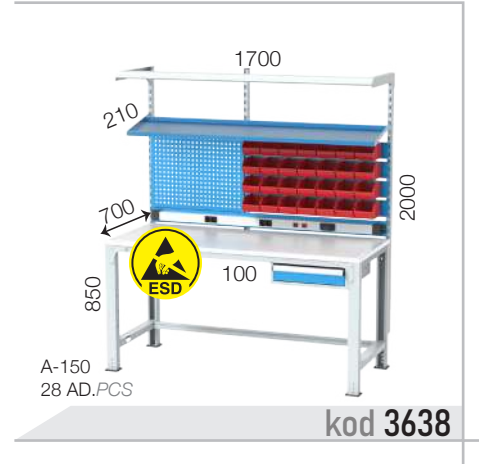
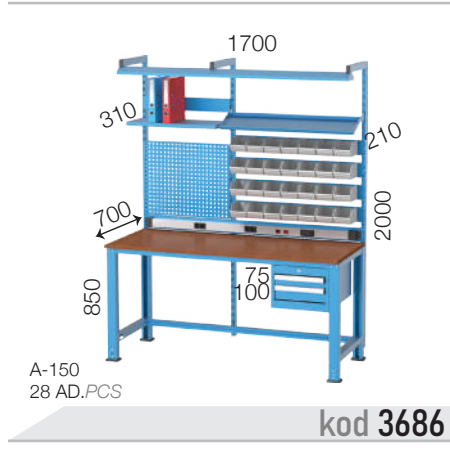



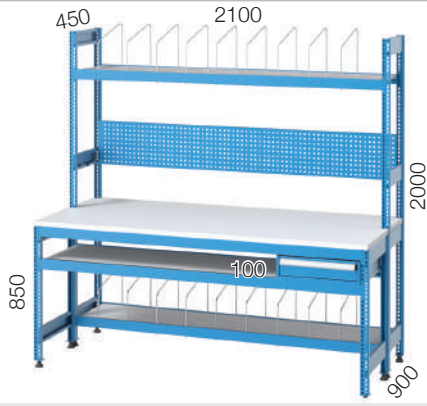

kod 3406

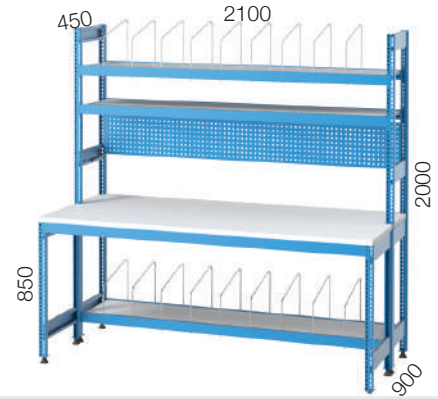

kod 3407

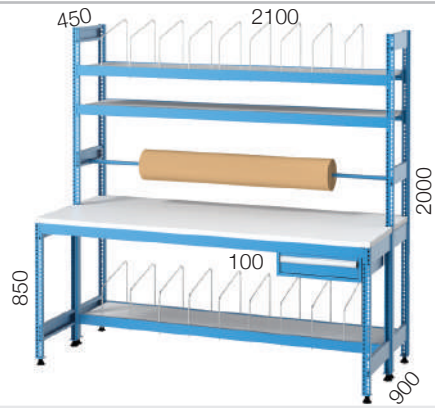

kod 3409



kod 3408

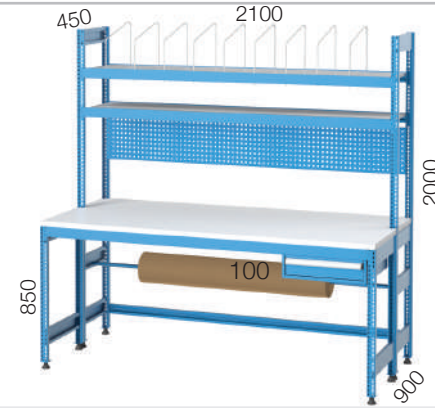

kod 3411

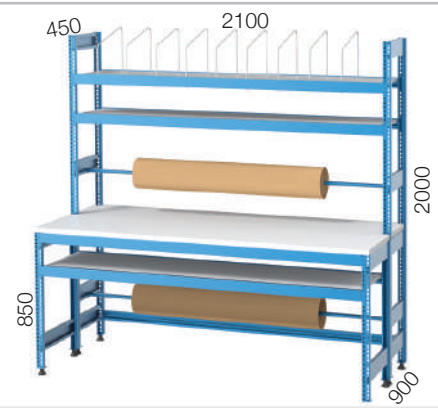

kod 3412

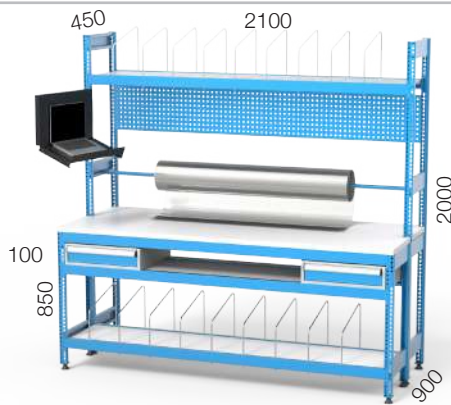

kod 3413



kod 3416

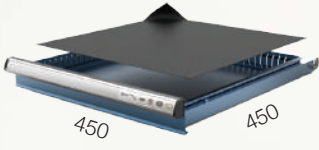



kod 3865



kod 3860



kod 3825



kod 3875



kod 3820



kod 3805



kod 3840



kod 3870



kod 3880



kod 3835



kod 3855



kod 3815

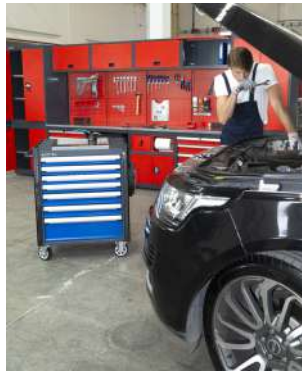



kod 8955



kod 8960



kod 8965



kod 8970

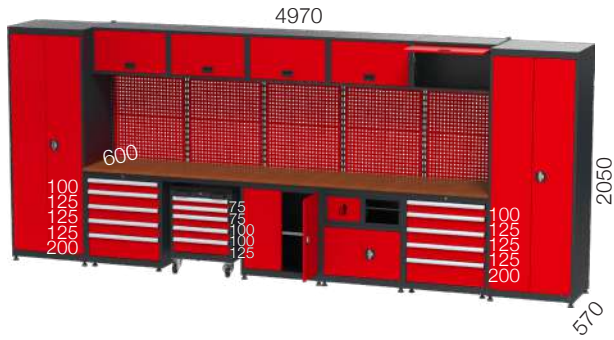

kod 8975



kod 8980



kod 8985



kod 8990



kod 8900-75.2000



kod 8900-75.1200



kod 8900-75.080



kod 8900-75.082



kod 8900-75.085



kod 8900-75.081



KÖŞE BANKO  
CORNER BENCH

kod 8900-75.778



kod 8900-75.447

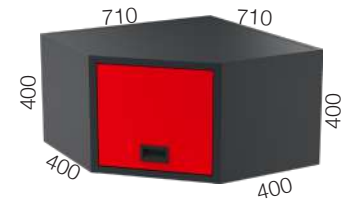

kod 8900-75.477



kod 8900-56.064



kod 8900-56.065



kod 8900-56.066

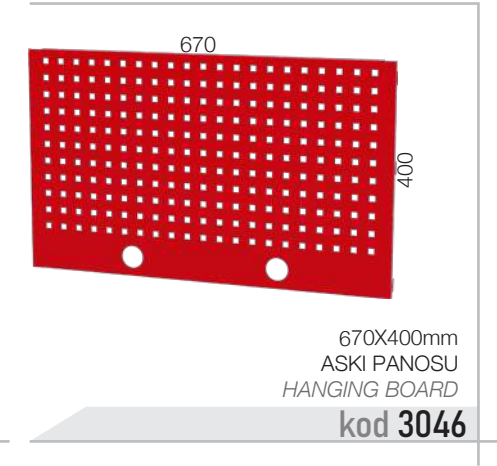
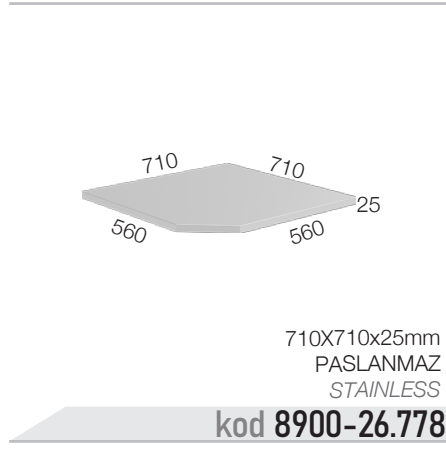
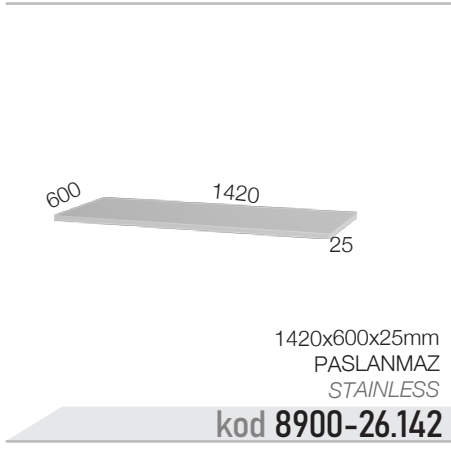
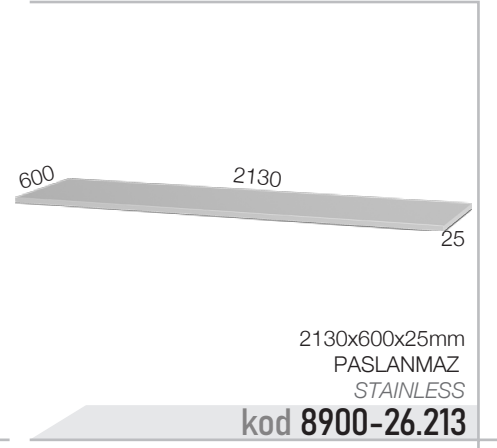
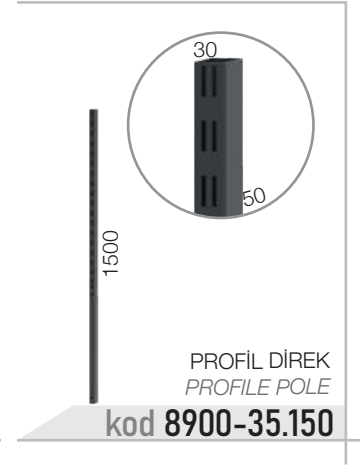
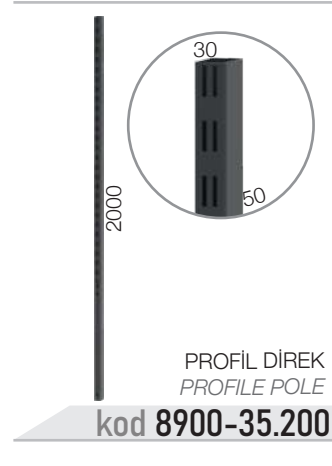
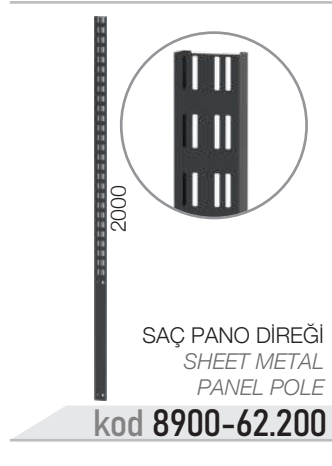
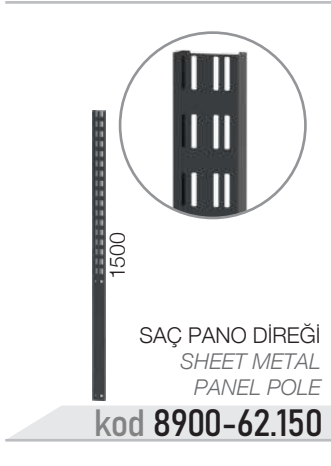

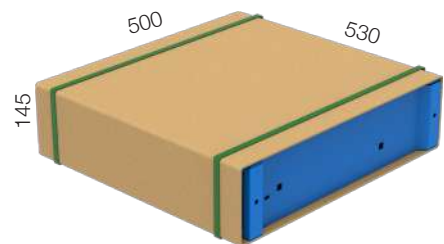
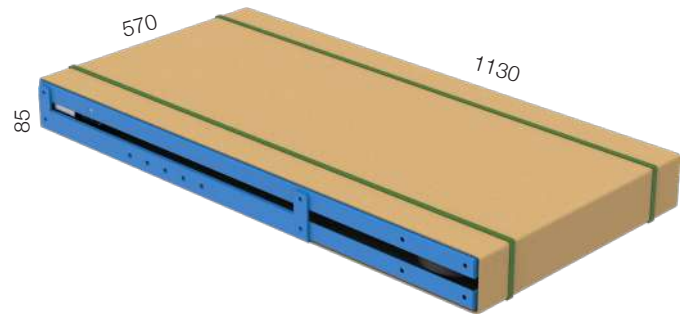
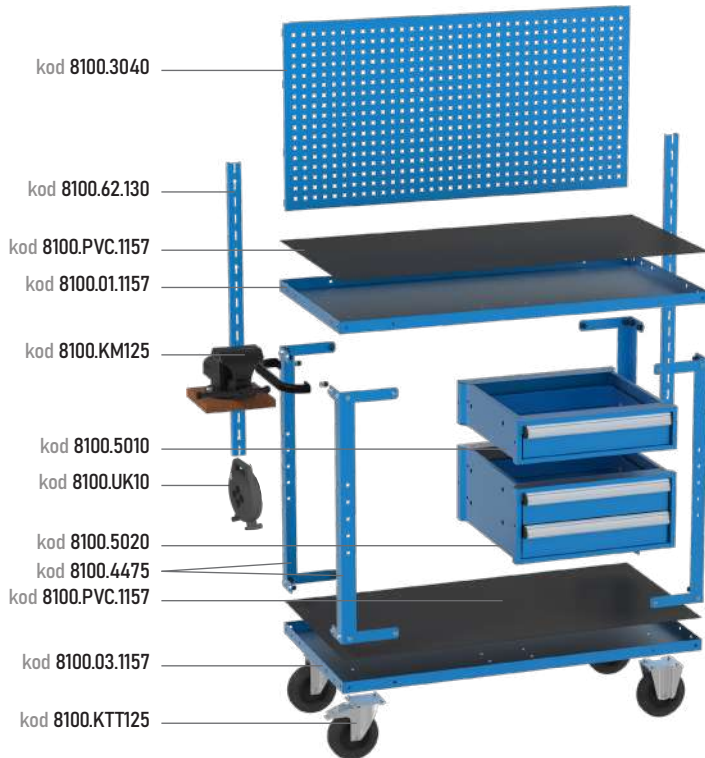



kod 8011



kod 8012



kod 8013



kod 8014



kod 8009



kod 8002



kod 8001



kod 8007



kod 8005



kod 8004



kod 8006



kod 8003

27x27 E

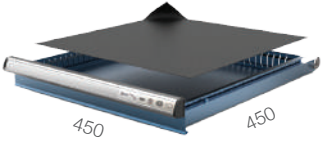

450

450

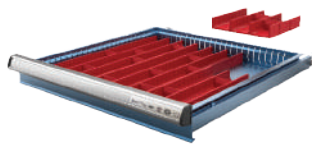

1,80 m



Çekme Kulplu  
Pulling Handle



Tekerli  
Wheeled



MDF Tabla  
MDF Slab



Merkezi Kilit  
Central Lock



İspanyolet Kilit  
Espagnolette Lock



Profesyonel Etiketleme  
Professional Labelling



Emniyet Mandalı  
Safety Latch



## 36X27 E



## 27X27 E



## 18X27 E

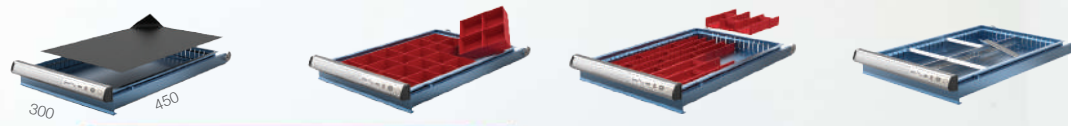

Çekme Kulplu  
Pulling Handle



Profesyonel Etiketleme  
Professional Labelling



Emniyet Mandali  
Safety Latch



Merkezi Kilit  
Central Lock



İspanyolet Kilit  
Espagnolette Lock

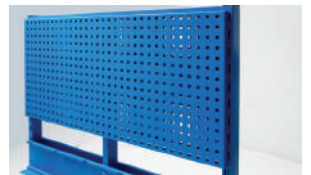

Aski Panosu  
Pegboard



Tekerli  
Wheeled



MDF Tabla  
MDF Slab

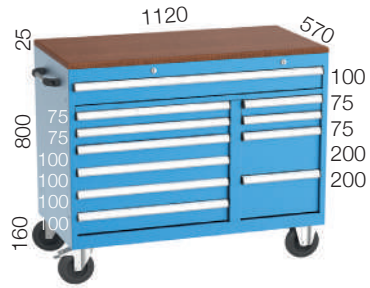

kod 8330



kod 8310



kod 8325

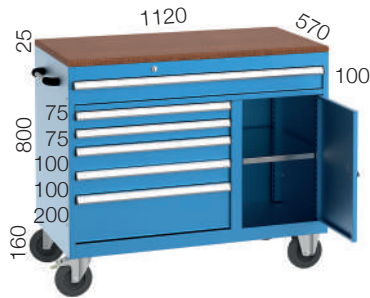

kod 8315

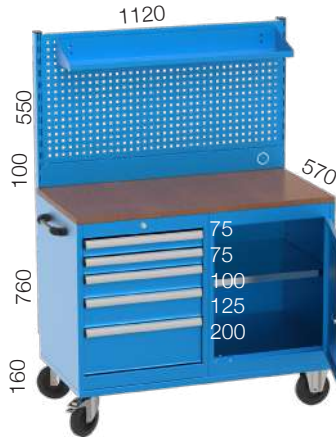

kod 8225

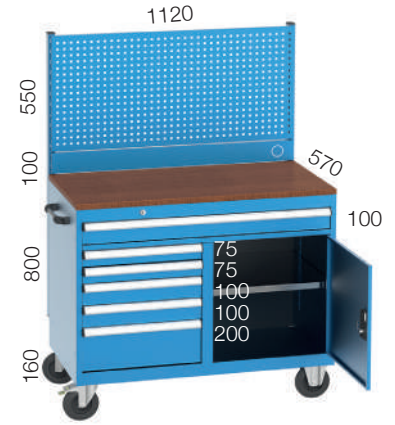

kod 8340

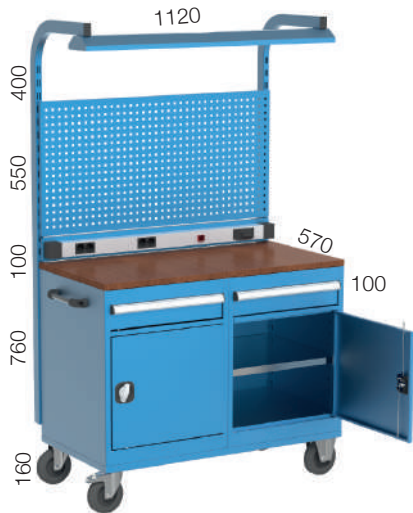

kod 8053



kod 8030

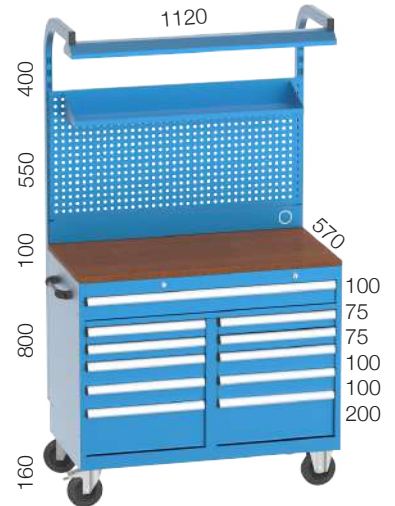

kod 8345

## 36X27 E



## 27X27 E

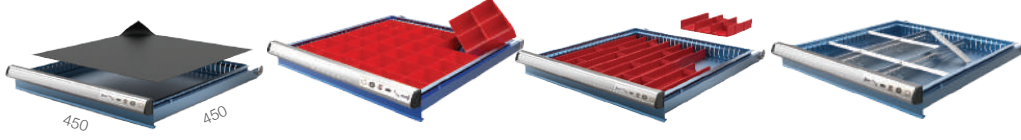

## 18X27 E

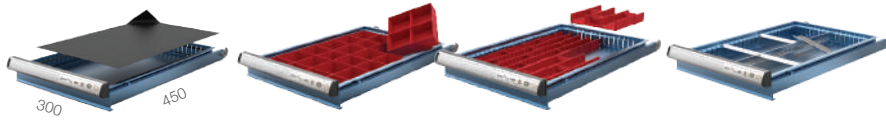

Çekme Kulplu  
Pulling Handle



Profesyonel Etiketleme  
Professional Labelling



Emniyet Mandalı  
Safety Latch



Merkezi Kilit  
Central Lock



İspanyollet Kilit  
Espagnolette Lock

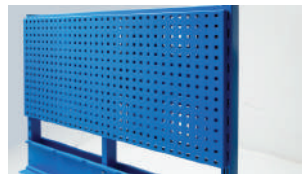

Aski Panosu  
Pegboard



Tekerli  
Wheeled



MDF Tabla  
MDF Slab



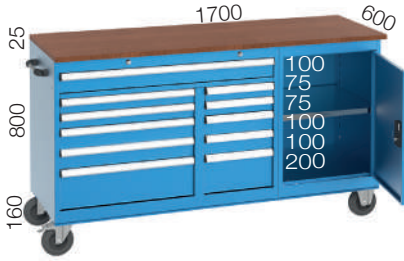

kod 8405

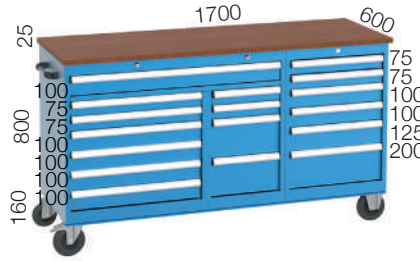

kod 8435



kod 8415

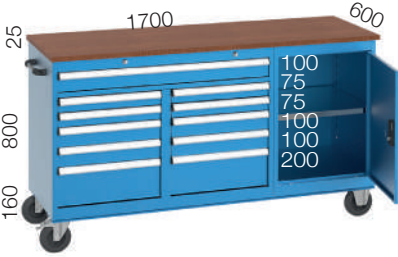

kod 8420



kod 8430

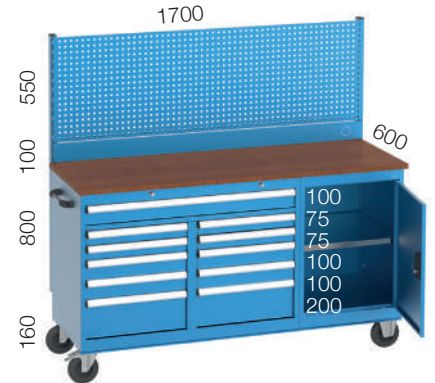

kod 8440



kod 8460

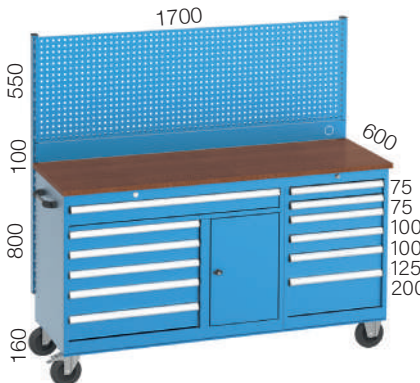

kod 8410



kod 8425







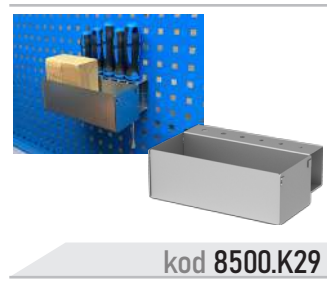
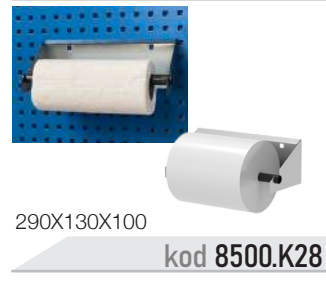
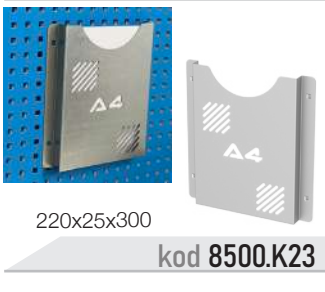
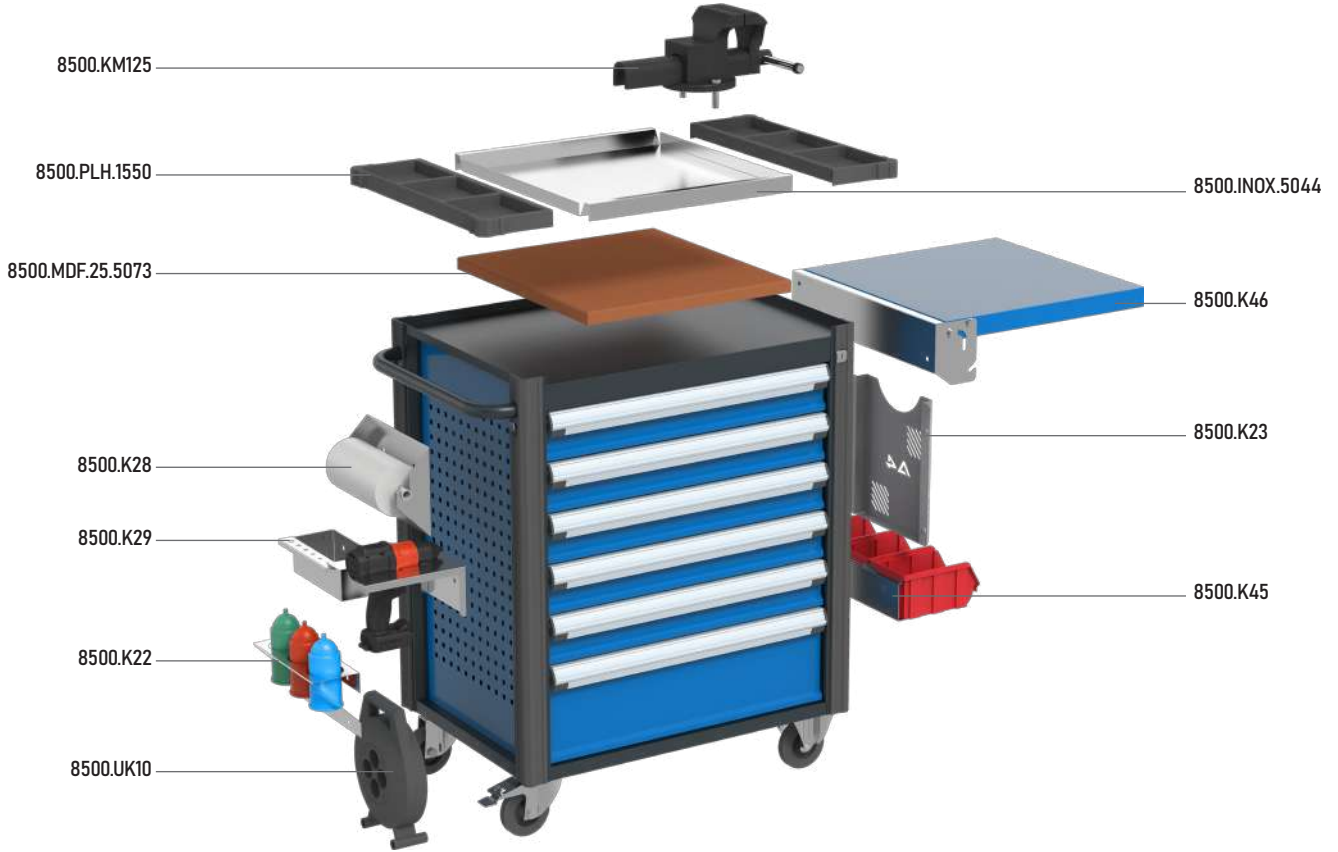





kod 8513



kod 8514



kod 8515



kod 8516

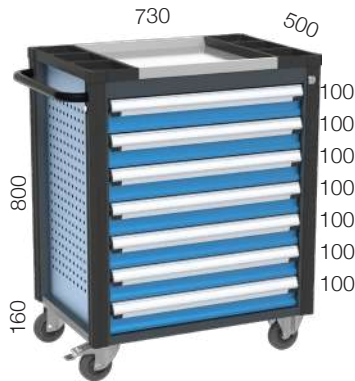

kod 8517



kod 8518



kod 8519



kod 8587





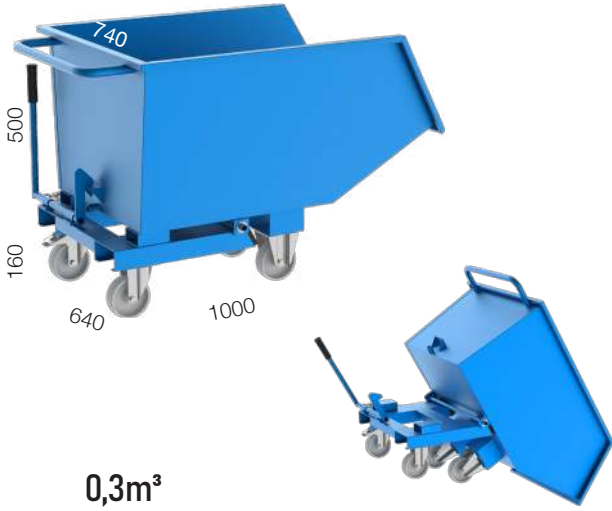

0,3m³

kod 4033

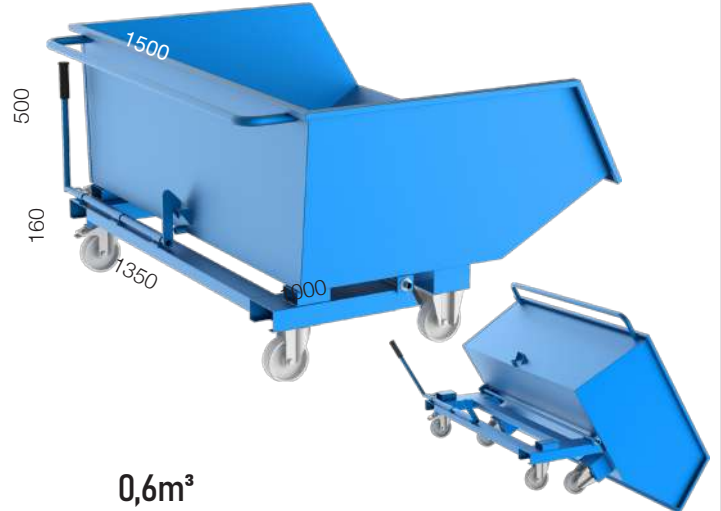

0,6m³

kod 4036



kod 4225



kod 4230



kod 4440



kod 4445

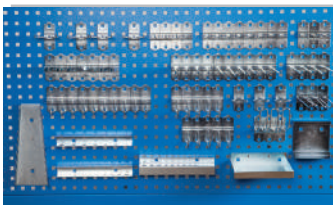
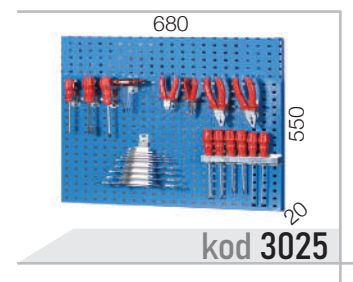
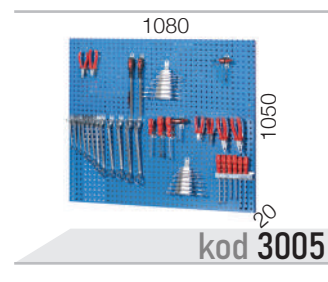
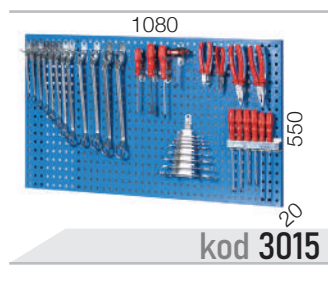
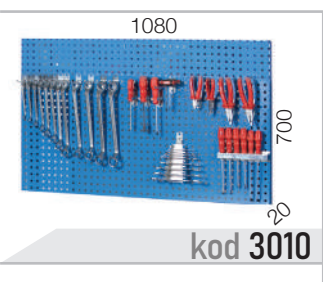
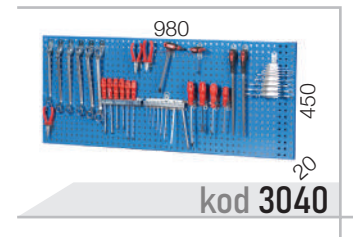
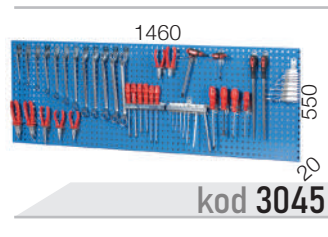
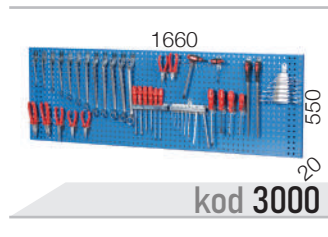
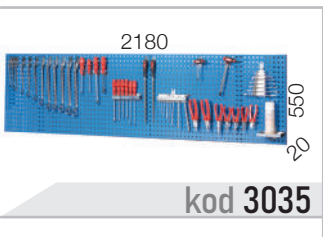
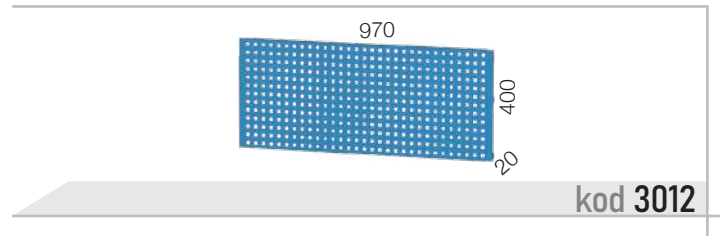
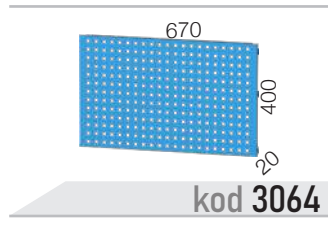
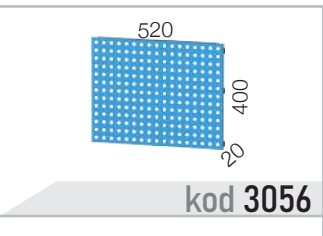

**75 Adetlik Set / 75 Pcs Hook Set**

- K1 :15 Adet / Pcs
- K2 : 4 Adet / Pcs
- K3 : 7 Adet / Pcs
- K4 :10 Adet / Pcs
- K5 : 3 Adet / Pcs
- K6 : 3 Adet / Pcs
- K7 : 3 Adet / Pcs
- K8 :10 Adet / Pcs
- K9 : 1 Adet / Pcs
- K10 :1 Adet / Pcs
- K11 :1 Adet / Pcs
- K12 :1 Adet / Pcs
- K13 :1 Adet / Pcs
- K16 :1 Adet / Pcs
- K15 :4 Adet / Pcs

**kod 300-75**

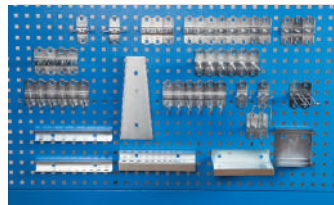

**50 Adetlik Set / 50 Pcs Hook Set**

- K1 :14 Adet / Pcs
- K2 : 6 Adet / Pcs
- K3 : 4 Adet / Pcs
- K4 : 6 Adet / Pcs
- K5 : 2 Adet / Pcs
- K6 : 2 Adet / Pcs
- K7 : 2 Adet / Pcs
- K8 : 6 Adet / Pcs
- K9 : 1 Adet / Pcs
- K10 :1 Adet / Pcs
- K11 :1 Adet / Pcs
- K12 :1 Adet / Pcs
- K13 :1 Adet / Pcs
- K16 :1 Adet / Pcs
- K15 :2 Adet / Pcs

**kod 300-50**

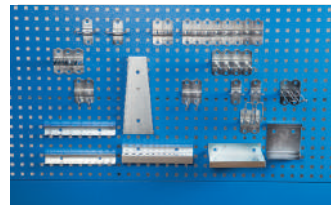

**35 Adetlik Set / 35 Pcs Hook Set**

- K1 :10 Adet / Pcs
- K2 : 4 Adet / Pcs
- K3 : 3 Adet / Pcs
- K4 : 2 Adet / Pcs
- K5 : 2 Adet / Pcs
- K6 : 2 Adet / Pcs
- K7 : 2 Adet / Pcs
- K8 : 2 Adet / Pcs
- K9 : 1 Adet / Pcs
- K10 :1 Adet / Pcs
- K11 :1 Adet / Pcs
- K12 :1 Adet / Pcs
- K13 :1 Adet / Pcs
- K16 :1 Adet / Pcs
- K15 :2 Adet / Pcs

**kod 300-35**

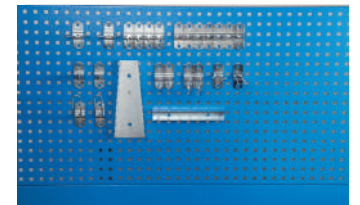

**25 Adetlik Set / 25 Pcs Hook Set**

- K1 :7 Adet / Pcs
- K2 :4 Adet / Pcs
- K3 :2 Adet / Pcs
- K4 :2 Adet / Pcs
- K5 :1 Adet / Pcs
- K6 :1 Adet / Pcs
- K7 :2 Adet / Pcs
- K8 :2 Adet / Pcs
- K9 : 1 Adet / Pcs
- K10 :1 Adet / Pcs
- K11 :1 Adet / Pcs
- K15 :2 Adet / Pcs

**kod 300-25**

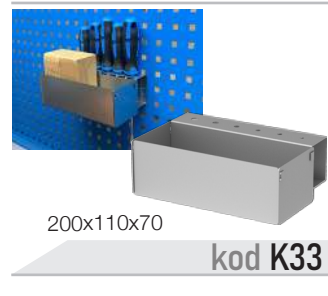
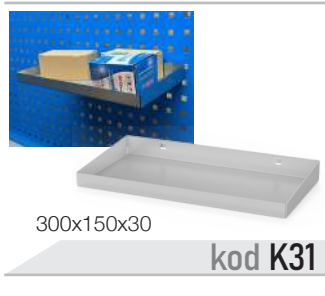
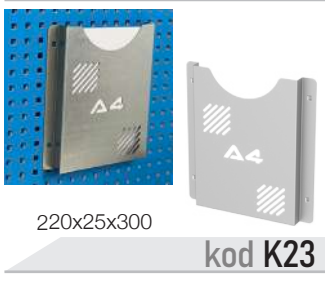
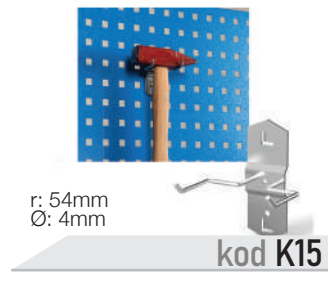
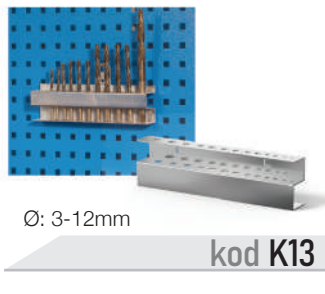
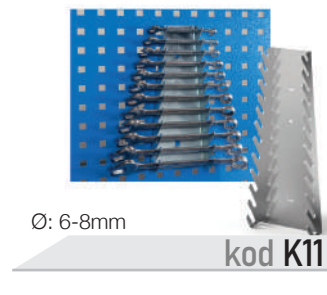
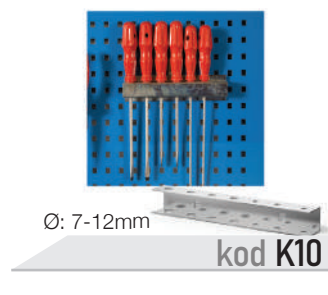
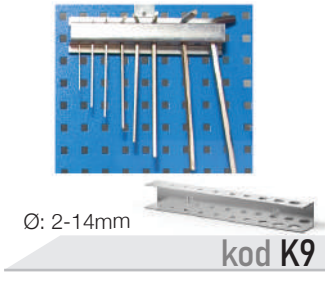
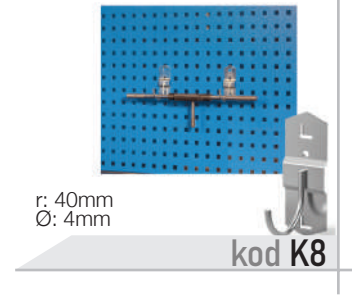
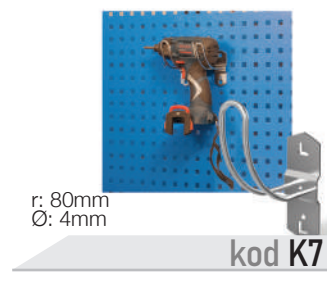
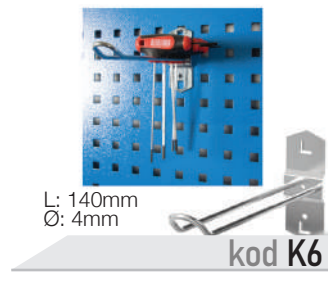
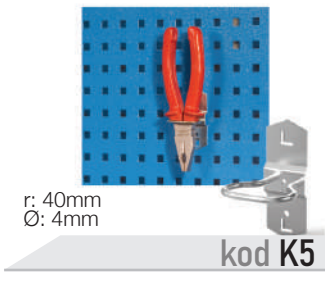
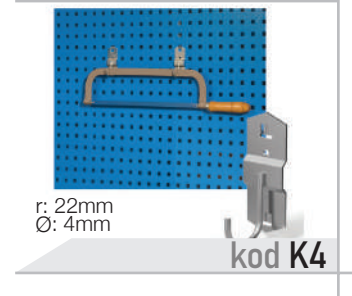
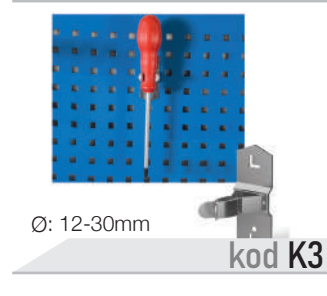
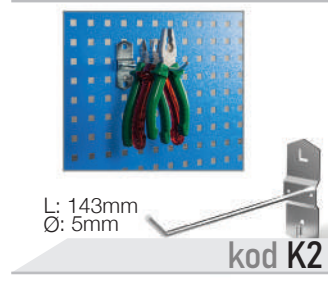
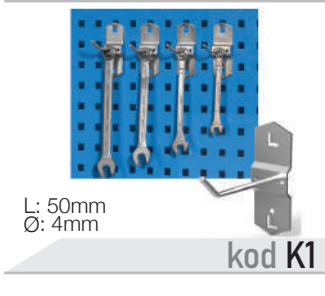

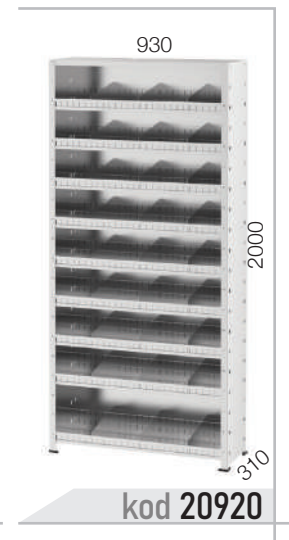
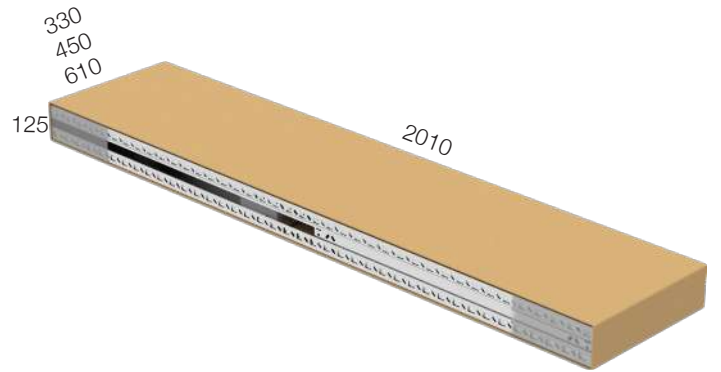

## MINIRACK RAFLAMA SİSTEMLERİ MINIRACK SHELF SYSTEMS



H	D	KAT SAYISI LAYERS	L 750 /KG	L 1000 /KG	L 1250 /KG	L 1500 /KG	L 750 /KG	L 1000	L 1250	L 1500
2000	500	5	350	300	200	150	20.550.075	20.550.100	20.550.125	20.550.150
2000	600	5	350	300	200	150	20.560.075	20.560.100	20.560.125	20.560.150



H	D	KAT SAYISI LAYERS	L 750 /KG	L 1000 /KG	L 1250 /KG	L 1500 /KG	L 750 /KG	L 1000	L 1250	L 1500
2000	500	5	350	300	200	150	20.551.075	20.551.100	20.551.125	20.551.150
2000	600	5	350	300	200	150	20.561.075	20.561.100	20.561.125	20.561.150



H	D	KAT SAYISI LAYERS	L 750 /KG	L 1000 /KG	L 1250 /KG	L 1500 /KG	L 750 /KG	L 1000	L 1250	L 1500
2500	500	5	350	300	200	150	25.550.075	25.550.100	25.550.125	25.550.150
2500	600	5	350	300	200	150	25.560.075	25.560.100	25.560.125	25.560.150



H	D	KAT SAYISI LAYERS	L 750 /KG	L 1000 /KG	L 1250 /KG	L 1500 /KG	L 750 /KG	L 1000	L 1250	L 1500
2500	500	5	350	300	200	150	25.551.075	25.551.100	25.551.125	25.551.150
2500	600	5	350	300	200	150	25.561.075	25.561.100	25.561.125	25.561.150





kod 20.44.0949.183



kod 20.44.1849.184



kod 20.44.1849.185



kod 20.44.0949.203

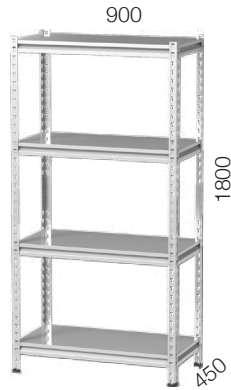

kod 20.44.1849.204



kod 20.44.1849.205

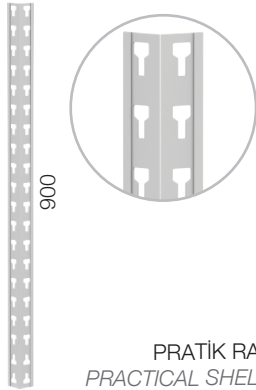

PRATİK RAF AYAK  
PRACTICAL SHELF FOOT  
kod 20.44.090.4412

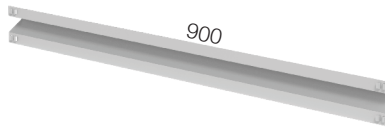

PRATİK RAF TRAVERS  
PRACTICAL SHELF TRAVERS  
kod 20.44.90.612

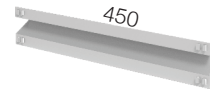

PRATİK RAF TRAVERS  
PRACTICAL SHELF TRAVERS  
kod 20.44.45.612

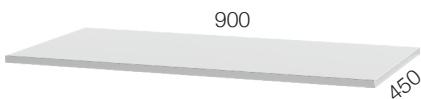

GALVANİZ TABLA  
GALVANIZED TABLE  
kod 20.44.945.020



BEYAZ SUNTALAM TABLA  
WHITE CHIPBOARD TABLE  
kod 20.44.945.018



PRATİK RAF ARA BAĞLANTI  
PRACTICAL SHELF INTERCONNECTION  
kod 20.44.020.4412





## ORTA TİP RAFLAMA SİSTEMLERİ / MEDIUM TYPE SHELFING SYSTEMS

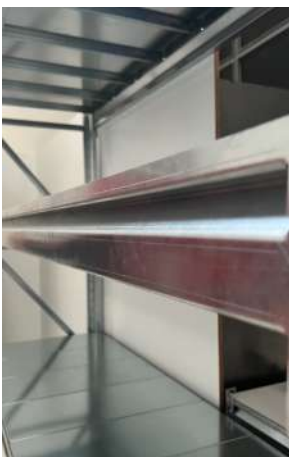

Travers boyları Traverse lengths	1000	1500	2000
Sipariş Kodu Order Code	CZ100	CZ150	CZ200
Taşıma Kapasitesi Carrying Capacity	900	600	450

H mm	B mm		
	600	800	1000
Sipariş Kodu / Order Code			
2000	20760	20780	207100
2500	25760	25780	257100
3000	30760	30780	307100

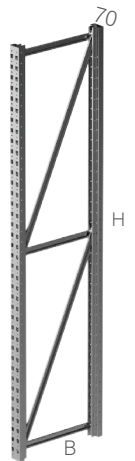

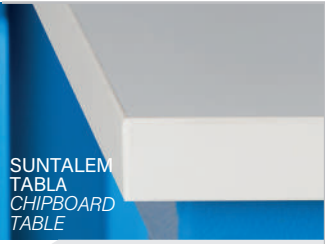

SUNTALEM  
TABLA  
CHIPBOARD  
TABLE

kod TS1765



KONTRAPLAK  
TABLA  
PLYWOOD  
TABLE

kod TK1770-1760-2260

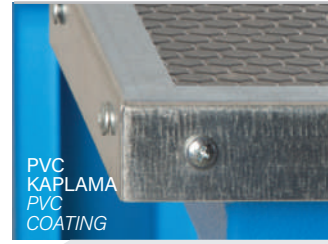

PVC  
KAPLAMA  
PVC  
COATING

kod PVC1770-1760-2260



GALVANİZ  
KAPLAMA  
GALVANIZED  
COATING

kod GZT1770-1760-2260



MDF  
TABLA  
MDF  
TABLE

kod MDF1770-1760-2260



PASLANMAZ  
KAPLAMA  
STAINLESS  
COATING

kod INOX1770-1760-1257



ESD  
KAPLAMA  
ESD  
COATING

kod ESD1770



MASİF  
KAPLAMA  
MASSIVE  
COATING

kod MSF1770-1760

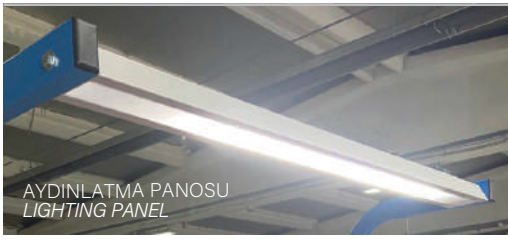

AYDINLATMA PANOSU  
LIGHTING PANEL

kod FTX-120 / FTX-170



DÖRTLÜ  
HAVA JAK'I  
QUAD AIR JACK

kod HJK4



ELEKTRİK PANOSU  
ELECTRICAL PANEL

kod EP15 / EP12



AMORTİSÖRLÜ KAPAKLI DOLAP  
CABINET WITH SHOCK  
ABSORBER DOOR

kod 3000-71.447



UZATMA  
KABLOSU  
EXTENSION  
CABLE

kod UK10



125MM  
MENGENE  
CLAMP

kod KM125



150MM  
MENGENE  
CLAMP

kod KM150



AVADANLIK RAFI (1700mm)  
PLASTIC BIN HOLDER (1700mm)

kod AVK170



AVADANLIK RAFI (980mm)  
PLASTIC BIN HOLDER (980mm)

kod AVK980



AVADANLIK RAFI (980mm)  
PLASTIC BIN HOLDER (980mm)

kod AVR980



AVADANLIK RAFI (500mm)  
PLASTIC BIN HOLDER (500mm)

kod AVR500



KAUÇUK TEKER  
RUBBER WHEEL

kod KTT100



KAUÇUK TEKER  
RUBBER WHEEL

kod KTT125



POLİÜRETAN TEKER  
POLYURETHANE WHEEL

kod PU100



POLİÜRETAN TEKER  
POLYURETHANE WHEEL

kod PU125



# 48

YILDIR BİTMİYEN  
YENİLİK TUTKUSU  
YEARS OF PASSION  
FOR INNOVATION

## KOCEL<sup>®</sup>A.S.

### Merkez / Head Office

Mahmutbey Mahallesi Köprü Caddesi No:10

Bağcılar / İSTANBUL / TÜRKİYE

**Telefon / Phone :** +90 (212) 445 35 29 (3 hat/**lines**)

**Fax :** +90 (212) 445 35 78

### Fabrika / Factory

GOSB 800. Sokak No:816-818

Gebze/KOCAELİ / TÜRKİYE

**Telefon / Phone :** +90 (262) 677 11 30 (10 hat/**lines**)

**Fax :** +90 (262) 677 11 40

**Gsm / Mobile :** +90 (533) 231 04 04

**İhracat / Export :** +90 (533) 303 38 77



### E-mail

info@kocel.com.tr

www.kocel.com.tr



/kocelcelik



/kocelcelik



/kocelcelik